

# TOOLS FOR THE ASSESSMENT OF SCHOOL AND HOSPITAL SAFETY FOR MULTI-HAZARDS IN SOUTH ASIA

## SCHOOL SAFETY TOOLKIT BOOK 2: RETRO MAINTENANCE MULTI-HAZARD SAFETY COMPLIANCE

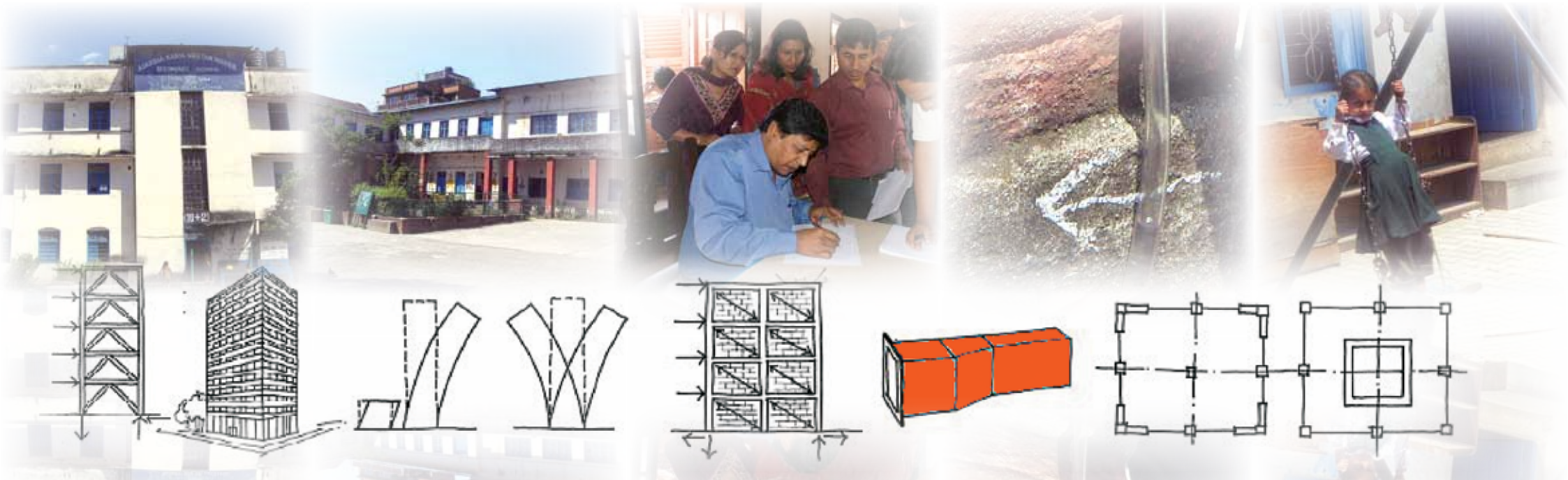





# TOOLS FOR THE ASSESSMENT OF SCHOOL AND HOSPITAL SAFETY FOR MULTI-HAZARDS IN SOUTH ASIA

SCHOOL SAFETY   
**TOOLKIT BOOK 2: RETRO MAINTENANCE**  
MULTI-HAZARD SAFETY COMPLIANCE

Copyright © United Nations Human Settlements Programme (UN-Habitat) and United Nations Office for Disaster Risk Reduction (UNISDR), 2012

**All rights reserved**

United Nations Human Settlements Programme (UN-Habitat)  
Regional Office for Asia and the Pacific  
ACROS Fukuoka Building, 8th Floor  
1-1-1 Tenjin, Chuo-ku, Fukuoka 810-0001, Japan  
Tel: +81-92 724-7121 / 23  
Fax: +81-92 724-7124  
E-mail: [habitat.fukuoka@unhabitat.org](mailto:habitat.fukuoka@unhabitat.org)  
Website: [www.unhabitat.org](http://www.unhabitat.org), [www.fukuoka.unhabitat.org](http://www.fukuoka.unhabitat.org)

United Nations Office for Disaster Risk Reduction (UNISDR)  
Asia Pacific Secretariat  
United Nations Secretariat Building  
Rajdamnern Nok Avenue, 10200 Bangkok, Thailand  
Phone: +66 -2 288-2745  
E-mail: [isdr-bkk@un.org](mailto:isdr-bkk@un.org)  
Website: <http://www.unisdr.org/asiapacific>

**DISCLAIMER**

The designations employed and the presentation of the material in this publication do not imply the expression of any opinion whatsoever on the part of the Secretariat of the United Nations concerning the legal status of any country, territory, city or area, or of its authorities, or concerning delimitation of its frontiers or boundaries, or regarding its economic system or degree of development. The analysis, conclusions and recommendations of the Toolkit do not necessarily reflect the views of the United Nations Human Settlements Programme (UN-Habitat), United Nations Office for Disaster Risk Reduction (UNISDR), and the Governing Council or its Member States.

Reference to names of firms and commercial products and processes do not imply their endorsement by the United Nations.

Excerpts from this publication, excluding photographs, may be reproduced without authorization, on condition that the source is indicated.

This publication was issued without formal editing.

HS Number: HS/093/12E  
ISBN Number: 978-92-1-133401-2 (Series)  
ISBN Number: 978-92-1-132509-6 (Volume)

Cover design: Peu Banerjee Das and Ilija Gubic

Design & Print Production: wps, tel +977-1-5550289, email [wwpsdm@wlink.com.np](mailto:wwpsdm@wlink.com.np)

## ACKNOWLEDGEMENTS

The Toolkit is a joint effort by the United Nations Human Settlements Programme Regional Office for Asia and the Pacific (UN-Habitat ROAP) and the United Nations Office for Disaster Risk Reduction (UNISDR) Asia Pacific Secretariat in partnership with the South Asian Association for Regional Cooperation Disaster Management Centre (SDMC).

The expert inputs from the SDMC were provided by O. P. Mishra, M. B. Rao and Mriganka Ghatak under the guidance of Satendra, Director SDMC. The preparation of the publication was coordinated by Mariko Sato, UN-Habitat and Madhavi Malalgoda Ariyabandu, UNISDR, supported by the team comprising Padma Sunder Joshi, Ilija Gubic, Pornpun Pinweha, under the guidance of Toshi Noda, former Regional Director, UN-Habitat ROAP; Hang Thi Thanh Pham and Nasikarn Nitiprathananun, under the guidance of the Senior Regional Coordinator, UNISDR Asia Pacific Secretariat, German Velasquez.

The lead technical advisor for developing the Toolkit is Prabir Kumar Das. Drawings in the Toolkit were contributed by Peu Banerjee Das.

The Governments of India, Nepal and Pakistan rendered a wide range of support. The Toolkit benefitted from technical inputs from ADB Nepal, UNDP India, UNESCO Pakistan, UN-Habitat Nepal and UN-Habitat Pakistan, WHO Nepal and the Nepal Risk Reduction Consortium (NRRRC).

### *Peer Reviewers*

The following experts contributed to the Toolkit with reviews of earlier drafts: Manohar Lal Rajbhandari, Rajan Suwal, Jishnu Subedi, Ramesh Guragain, Sunil Khadka, Chandan Ghosh, and Ranjini Mukherjee.

### *Expert Group Meeting, March 25-26, 2012, Kathmandu, Nepal*

The earlier drafts of the Toolkits were reviewed by the following experts at the EGM: Damodar Adhikary, Mukunda Adhikari, Lin Aung, Deepak Raj Bhatt, Tanka Prasad Bhattarai, Bal Krishna Bhusal, Tirtharaj Burlakoti, P. B. Chand, Meen Bahadur Chhetri, Tulsi Prasad Dahal, Mriganka Ghatak, Ramesh Guragain, Sabina Joshi, Sagar Joshi, Sunil Khadka, Hamid Mumtaz Khan, Sardar Muhammad Nawaz Khan, Sarosh Hashmat Lodi, Ram Luetel, Arun Mallik, Rajesh Manandhar, Prem Nath Maskey, Abha Mishra, Giridhar Mishra, Prafulla Man Singh Pradhan, Manohar Lal Rajbhandari, Shreejana Rajbhandari, Moira Reddick, Sujata Saunik, Gyanandra Shakya, Arinita Maskey Shrestha, Deepak Shrestha, Hari Darshan Shrestha, Rekha Shrestha, Santosh Shrestha, Sudha Shrestha, Tulasi Sitaula, Paolo Spantigati, Jishnu Subedi, Rajan Suwal, Kishore Thapa, Man Bahadur Thapa, Bhushan Tuladhar, Sainendra Uprety, Jhapper Singh Vishokarma and Syed Arsalan Sabah Zaidi. UN-Habitat Nepal Office team has provided the logistic support.

Field Testing of the Toolkits in India, Nepal and Pakistan has contributed to the modification of the draft tools. Tools were tested in Guwahati and Shimla in India, Bhaktapur, Kirtipur and Lalitpur in Nepal, with the help of Santosh Shrestha, as well as in Raheem Yar Khan, Punjab in Pakistan.

The preparation of the Toolkit has drawn upon the existing tools and good practices including materials shared by UNESCO Pakistan, UNDP India, WHO, PAHO, ADB, National Institute of Disaster Management (NIDM) India, Nepal Risk Reduction Consortium (NRRRC), National Society for Earthquake Technology (NSET) Nepal, Nepal Health Sector Support Programme, UN-Habitat Myanmar, Nepal and Pakistan Offices.

UN-Habitat and UNISDR are grateful for the financial support provided by the Global Facility for Disaster Reduction and Recovery (GFDRR).

## FOREWORD

South Asia is a hotspot of disasters. The tectonic, geomorphological and hydro meteorological set up of the region along with socio- economic conditions make it extremely vulnerable to various natural disasters. The South Asian countries located in the seismically active northern fringes like Afghanistan, Bhutan, India, Nepal and Pakistan have been witness to several devastating earthquakes in the past. Similarly, the countries with exposed coastline like Bangladesh, India, Maldives and Sri Lanka have borne the fury of cyclones, tsunamis and coastal erosion. In addition to these, floods, landslides, droughts have also caused devastation in the countries of South Asia.

It has been observed that in case of natural disasters the important community and lifeline structures such as schools and hospitals receive irrecoverable damages and it takes a long time to restore them to function for the communities. The safety of these structures becomes even more important in light of the fact that, when disasters strike, they also serve as vital centers for community shelter extended to the affected. The safety and resilience of lifeline structures and a strong need to adopt a toolkit which addresses the critical aspects of safety of schools and hospitals in vulnerable areas thus has been identified as a priority. South Asian Association for Regional Cooperation (SAARC) Disaster Management Centre (SDMC), New Delhi India identified the vitality of the issue and in follow up to the SAARC Road Map for Earthquake Risk Mitigation; a toolkit for Rapid Visual Assessment (RVA) of schools and hospitals has been developed in 2011.

Extending this initiative further, UN-Habitat, in partnership with UNISDR Asia Pacific Secretariat and the SDMC has taken up the mission of developing a standardized Tool Kit for the assessment of safety of school and hospital structures to multiple hazards in the region. This Tool Kit adopts the basic framework from the SDMC template on Risk and Vulnerability Analysis of Schools and Hospitals, and extends to the multiple hazards, the region is prone to such as earthquake, flood, cyclone, fire etc.. It addresses the safety of new lifeline structures as well as retrofitting of existing structures to make them resilient and safe for the communities during disasters. The Tool Kit targets two groups placed at the extreme ends of disaster management spectrum: the Top Level Management and the End Users. The development of the Tool Kit has undergone several rigorous stages of review

and feedback from experts from the region and field observations. Finally at a stimulating Expert Group Meeting (EGM) held in Kathmandu a distinguished panel of experts assembled and deliberated on the finer technical aspects. Incorporation of the recommendations of the EGM has further enriched the contents of the Tool Kit.

The Tool Kit is placed in the hands of the intended users at a very crucial juncture of disaster risk reduction initiatives evolving in the SAARC region, through various consultative, research and policy planning endeavours. It is expected that the Tool Kit will be useful to a myriad cross section of players engaged in disaster risk reduction in the SAARC region.



A handwritten signature in black ink, appearing to read 'Satendra', written over a white background.

Satendra  
Director  
SAARC Disaster Management Centre

## FOREWORD

It gives us great pleasure to introduce this toolkit entitled **Tools for the Assessment of School and Hospital Safety for Multi-Hazards in South Asia.**

South Asia is one of the most disaster prone regions in the world. A combination of multiple layers of geo-physical and climatic hazards, as well as a complex range of physical, social and economic vulnerabilities contribute to this. In 40 years, from 1967 – 2006, some 784 reported disasters took 800,000 lives and affected over two billion people. Economic losses amounted to an estimated \$80 billion. This region also has an exceptionally high annual urban growth rate, with the accompanying challenges of increased urban risk and vulnerability.

Six out of the eight countries of South Asia - Afghanistan, Pakistan, India, Nepal, Bhutan and Bangladesh, are located in the highly seismically active Himalayan-Hindu Kush belt. Sri Lanka, Maldives and large parts of the coastal areas of Bangladesh, India and Pakistan are vulnerable to tsunamis, cyclones and flooding. Substantial damages were caused to education and health facilities by a series of disasters in the recent years such as the 2004 Indian Ocean Tsunami, the 2005 Kashmir earthquake, Cyclone Sidr in 2007, and the 2010 and 2011 floods in Pakistan. The resultant loss of life of students, teachers and health workers, and the collapse of school and hospital buildings clearly indicate the need to ensure the safety of these critically important facilities.

This toolkit, which comprises four sets of assessment tools for both existing and new schools as well as hospitals, is a result of cooperation amongst the South Asian Association for Regional Cooperation (SAARC), the United Nations Human Settlements Programme (UN-Habitat) and the United Nations Office for Disaster Risk Reduction (UNISDR).

The Toolkit serves Afghanistan, Bangladesh, Bhutan, India, Maldives, Nepal, Pakistan and Sri Lanka, and complements the recent work of the SAARC Disaster Management Centre and its publication '*Rapid Structural and Non-Structural Assessment of School and Hospital Buildings in SAARC Countries*'. The aim is to offer user-friendly tools for the multi-hazard context of South Asia, targeting policy makers, experts, and end-users responsible for local level planning and implementation.

The toolkit explains the complex process of retrofitting existing facilities as well as ensuring safe construction of new infrastructure in a practical manner. It facilitates informed decision-making and actions to achieve school and hospital safety. Importantly, the tools have been reviewed by a group of experts including policymakers, professionals and users, and have undergone field testing in several locations in India, Nepal and Pakistan.

This new approach will provide concrete indices in support of the recommendations of the 2011 Chair's summary of the Global Platform for Disaster Risk Reduction, the global advocacy campaigns: *One Million Safe Schools and Hospitals, Making Cities Resilient - My City is Getting Ready* and, *the World Urban Campaign*. We believe this is an important step towards achieving risk reduction targets and building the resilience of nations and communities in the South Asian sub-continent. The toolkit demonstrates that making critical infrastructure safe from disasters is achievable.



Joan Clos,  
UN Under-Secretary-General and  
Executive Director, UN-Habitat - United  
Nations Human Settlements Programme



Margareta Wahlstrom,  
UN Special Representative  
of the Secretary-General  
for Disaster Risk Reduction  
(DRR), UNISDR



# CONTENTS

THERE ARE FOUR INDEPENDENT BOOKS ON MULTI HAZARD SAFETY COMPLIANCE ASSESSMENT OF NEW DESIGN AND EXISTING HOSPITALS AND SCHOOLS

THIS IS BOOK 2

**SCHOOL SAFETY**  
**TOOLKIT BOOK 1: NEW DESIGN**  
**Multi-Hazard Safety Compliance**



CONSULTANTS WILL FILL IN TOOLKIT I & PRESENT IT TO TLM, EDUCATION

CHAPTER 1  
 1.1 Background  
 1.2 The Toolkits  
 1.3 Who does what and how  
 1.4 Types Of Hazards  
 1.5 Desktop Research  
 1.6 Process

CHAPTER 2  
 2.1 How to Use the Toolkit I

Annexure I: Seismic Safety Evaluation  
 Annexure II: Wind Safety Evaluation  
 Annexure III: Flood Safety Evaluation  
 Annexure IV: Fire Safety Evaluation

**HOSPITAL SAFETY**  
**TOOLKIT BOOK 1: NEW DESIGN**  
**Multi-Hazard Safety Compliance**



CONSULTANTS WILL FILL IN TOOLKIT I & PRESENT IT TO Top Level Management (TLM), HEALTH

Chapter 1  
 1.1 Background  
 1.2 The Toolkits  
 1.3 Who does what and how  
 1.4 Types of Hazards  
 1.5 Desktop Research  
 1.6 Process

Chapter 2  
 2.1 How to Use the Toolkit I

Annexure I: Seismic Safety Evaluation  
 Annexure II: Wind Safety Evaluation  
 Annexure III: Flood Safety Evaluation  
 Annexure IV: Fire Safety Evaluation

**SCHOOL SAFETY**  
**TOOLKIT BOOK 2: RETRO MAINTENANCE**  
**Multi-Hazard Safety Compliance**



SURVEY AGENCY/NGO WILL FILL IN TOOLKIT II & PRESENT IT TO TLM, EDUCATION

CHAPTER 1	3	
1.1 Background	3	
1.2 The Toolkits	3	
1.3 Who does What and How	4	
1.4 Types Of Hazards	4	
1.5 Desktop Research	4	
1.6 Process	4	
CHAPTER 2	5	
2.1 How to Use the Toolkit II	5	
CHAPTER 3	11	
3.1 General Information: School	11	
Annexure I: Seismic Safety Evaluation	15	
Annexure II: Wind Safety Evaluation	25	
Annexure III: Flood Safety Evaluation	33	
Annexure IV: Fire Safety Evaluation	39	
Annexure V: Supplement: School Condition Assessment Support to EMIS	44	
Annexure VI: Field Test	54	

TEACHERS+ SMC WILL FILL IN SUPPLEMENT, A SUPPORT TO EMIS & PRESENT IT TO TLM, EDUCATION

**HOSPITAL SAFETY**  
**TOOLKIT BOOK 2: RETRO MAINTENANCE**  
**Multi-Hazard Safety Compliance**



SURVEY AGENCY/NGO WILL FILL IN TOOLKIT II & PRESENT IT TO TLM, HEALTH

Chapter 1  
 1.1 Background  
 1.2 The Toolkits  
 1.3 Who does what and how  
 1.4 Types of Hazards  
 1.5 Desktop research  
 1.6 Process

Chapter 2  
 2.1 How to use the Toolkit II

Chapter 3  
 3.1 General information: Hospital

Annexure I: Seismic Safety Evaluation  
 Annexure II: Wind Safety Evaluation  
 Annexure III: Flood Safety Evaluation  
 Annexure IV: Fire Safety Evaluation  
 Annexure V: Supplement to Toolkit II: Hospital Condition Assessment: Support to HHS  
 Annexure VI: Field Test

MEDICAL STAFF WILL FILL IN SUPPLEMENT, A SUPPORT TO HHS & PRESENT IT TO TLM, HEALTH



## GLOSSARY

**Buoyancy effect:** Sometimes, floodwater level in a place may rise considerably higher than the bottom of a building's basement or an underground tank. In such case, the building or the water tank will experience upward push. This is called buoyancy. Such movement may cause a breaking and/or separation of the connecting pipes and other service lines

**Design flood elevation** is a regulatory flood height level adopted by a community at local level. Such level is based on observed data for a long time. It helps to determine the safe plinth height of buildings in a flood prone area.

**Drift** is the horizontal displacement of a building due to seismic, wind or any other horizontal force

**Ductility:** Any metal that has the ability to get stretched without being damaged is a ductile material and this property of materials is called ductility. Mild steel, copper, etc. are ductile materials.

**Fault** is a discontinuity in a volume of rock, across which there has been significant displacement as a result of earth movement. A fault is called active if it is likely to have another earthquake in future. Faults are commonly considered to be active if they have moved one or more times in the last 10,000 years.

**Frame structure** is the skeleton of a building made of wood, steel, or reinforced concrete that supports all kinds of loads. In a frame structure load is transferred from slabs → beams → columns → foundation. All member joints in framed structure can withstand bending.

**Geotechnical investigation** is performed by geotechnical engineers or engineering geologists

to obtain information on the physical properties of soil and rock around a site to design earthworks and building foundations.

**Grid** is defined principally by column positions and the main beams spanning between them. The sketch on the right is a building plan showing column locations. The dotted lines are the grids.

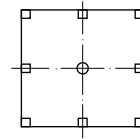

**Liquefaction** is a state in which un-compacted saturated soil acts more like a dense liquid than solid during earthquake. Water saturated granular soil such as silts, sands, and gravel that are free of clay particles are prone to liquefaction. Buildings undergo severe damage/sinking when the soil beneath suddenly behaves like a liquid due to liquefaction.

**Load path** means a path that forces pass through to the foundation of a structure. A continuous load path is like a chain that ties the house together from the roof to the foundation. The sketch on the right shows a discontinuous load path, which is not good for seismic or wind load.

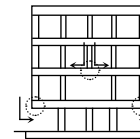

**Masonry structure:** When brick, stone, blocks, etc are laid in courses with cement/lime/mud mortar as bed is called a masonry structure. Usually used in wall, roof, etc.

**Reinforced Cement Concrete (RCC):** Concrete consists of cement, sand, aggregate and water. The solid portions are first mixed thoroughly and then water is added and then mixed further. This is cast with mild steel rods embedded inside. It is called RCC

when it turns solid. RCC can take both tension and compression.

**Retaining wall** is built in order to hold back earth which would otherwise move downwards.

**Seismic load** is caused due to earthquake-generated agitation to a building or structure. Seismic load acts at contact surfaces of a structure either with the ground [http://en.wikipedia.org/wiki/Seismic\\_loading](http://en.wikipedia.org/wiki/Seismic_loading) - cite\_note-1, or with adjacent structures

**Seismic micro zoning** is the process of subdividing an earthquake prone area into zones with respect to geological and geophysical characteristics of the sites. It provides information on ground shaking, liquefaction susceptibility, landslide and rock fall hazard, earthquake-related flooding. Seismic micro zoning maps of construction areas must be consulted when designing earthquake-resistant structures

**Seismic zone** is a region in which the rate of seismic activity remains fairly consistent. e.g. IS 1893, 2002 shows that there are four seismic zones in India- Zone V, the severest earthquake prone and Zone II the least.

**Short column effect:** Column heights within the same storey could be different if a building is on a slope or if there is a part mezzanine floor within the storey. In such case the columns of shorter heights are stiffer and attract more earthquake forces than the taller ones. If not designed adequately, the shorter ones may fail, which is attributed as failure due to short column effect.

**Storm surge** is an offshore rise of water due to a low pressure weather system, e.g., during cyclones. Storm surges are caused primarily by high winds pushing on

the ocean's surface. The wind causes the water to pile up higher than the ordinary sea level. This could be highly damaging for the buildings along coast lines.

**Tsunami**, in Japanese, is "harbour wave". It is a series of water waves caused by the displacement of a large volume of water in an ocean or a large lake. The various reasons for tsunami could be earthquakes, volcanic eruptions and other underwater explosions, landslides, meteorite impacts etc.

**Unreinforced masonry** is a type of building where the structural walls are made of brick, block, tiles, adobe or other masonry material, that is not braced by reinforcing rods.

**Wind born missile:** If a site has trees, waste bins/cans, debris or other materials that can be moved by the wind, during cyclone or high wind they may fly and strike your building by damaging windows, doors, etc.

Elements that can fly in high wind and damage buildings are called wind borne missiles. One must consider this effect in design.

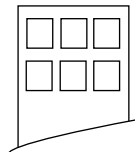

**Wind Tunnel effect:** if one takes a walk between tall buildings, or in a narrow mountain pass, one will notice that the wind speed is much higher than the general level. The air becomes compressed on the windy side of the buildings or mountains, and its speed increases considerably between the obstacles to the wind. This is known as a "tunnel effect". If your building site is prone such effect, it must be considered in design.

# CHAPTER 1

## 1.1 BACKGROUND

Major Asian cities are located, by and large, across flood plains or in coastal areas. Over 50% of the urban populations are living in small and medium size cities with less than 500,000 populations that are growing faster and may not be able to cope with emerging urban issues. Considering the increased urban risks many of our cities are facing, it is clear that there is a need to integrate disaster risk reduction into the urban planning and local planning practices.

The Chairs summary of the GPDRR 2009 calls for specific targets to achieve critical infrastructure safety, as stated: "By 2011 a global structural evaluation of all schools and hospitals should be undertaken and that by 2015 concrete action plans for safer schools and hospitals should be developed and implemented in all disaster prone countries".

To respond to such a situation, UN-Habitat Bangkok Office in partnership with UNISDR Asia Pacific Secretariat decided to develop Toolkits which will facilitate the assessment of the safety of critical infrastructure, focusing on schools and hospitals in South Asia.

The obvious question in the beginning was why one needs another toolkit when there is a large body of available technical literature on disaster safe school and hospitals. Detailed examination of the existing literature and interviewing people directly involved with the supply and maintenance revealed that disaster safety of hospitals and schools from the owners' and users' perspective is inadequately covered. This is an important area since disaster safety is not just a technical issue; it needs proactive participation of both the owners and end-users in the endeavor of safe schools and hospitals.

Under such circumstance, this project viewed the top level management and the end-users as the two most important key role players. Top level management here means the Director Generals (Health/education) along with the line directors. The end users are the school teachers and the doctors and medical staff at school and hospital respectively.

Any hospital or school is planned, designed, constructed and handed over to the end-users, who use the facilities for at least fifty years before being replaced with a new one. The top level management is responsible for ensuring that the buildings conform to the safety standards throughout their whole life cycle. Safety is a complete package spanning over the entire lifespan of a building.

## 1.2 THE TOOLKITS

**New Construction:** For supply of new buildings, while management has to rely on architect(s) and engineers, it is equally important for them to act as INFORMED CLIENTS while interacting with the architects and engineers, in the endeavour to make the hospital/ school safe. The focus of the toolkit is to get an idea on the level of compliance of a new design with safety norms/codes/standards. This is possible only if the toolkit is simple, objective type and graphical. It should also be comprehensive enough to suit the busy schedule of the top level management. This has been termed as **TOOLKIT I**.

- The Toolkit I is designed to enhance awareness and capacity of the top level management to take meaningful role in creating safe new hospital and school. The output of the Toolkit I will form part of a national database on safety compliance for future reference and as a commitment from the architect's and engineer's side.

**Existing Buildings & Facilities:** For the existing buildings, it is most important to know whether they are safe according to the latest building codes, failing which there may be a need for retrofitting. The second important issue is the current physical condition of the existing infrastructure. Buildings tend to live long in a cost effective manner, if maintained periodically.

It may be noted that there is a lack of awareness on retrofitting, though all are aware of maintenance. Currently the data collection system in health and education departments are maintenance-centred. As a result, these two aspects of safety are mostly dealt in isolation. It will be cost effective and consistent with safety if these two are viewed as a single whole - retrofit cum maintenance. To bring in a paradigm shift in this regard, it is important to develop the following;

- A suitable toolkit for the top level management to keep track with the retrofitting requirements of the hospitals and schools - termed as **TOOLKIT II**.
- While Toolkit II will provide a comprehensive picture on the retrofitting requirements, it needs data on existing physical conditions of the buildings to make rationalised decision on retrofit cum maintenance actions. A supplement has been designed to address this.

It addresses two issues, a) makes additions and modifications to the existing **EMIS/HIIS**<sup>1</sup> systems, b) provides a graphical guide book to help the end users to acquire more objective type data on maintenance and some aspects of retrofitting within the framework of existing HIIS and EMIS forms. The supplement has been designed within the capability of school teachers and medical staff

<sup>1</sup> Education Management Information System (EMIS), Health Infrastructure Information System (HIIS)

- The Toolkit II and the Supplement will enable the line directorates to screen those which would need further investigation for retrofitting need assessment by experts. For the rest, the toolkit and the supplement will help in prioritizing the maintenance needs

### 1.3 WHO DOES WHAT AND HOW

**Toolkit I (Multi-Hazard safe New Design: Hospital & School):** The appointed architect/ engineer will use toolkit I and report to the top level management on the level of compliance of the design with safety norms. Once top level management is satisfied with the level of safety compliance of design, the filled-in Toolkit I will be archived in the computer for future reference.

**Toolkit II: (Multi-Hazard safe Retrofitting: Existing Hospital & School):** The top level management will appoint NGO/agency or similar group of people to do the retrofitting need assessment once in three to four years.

**Supplement to Toolkit II:** The medical staff and the school teachers with school management committee will use this as an extension to the HHS and EMIS data format. This will be done annually.

The toolkit II and the supplement will enable top level management to estimate and prioritize the retrofit cum maintenance works in a holistic manner. This will also enable one to decide whether detailed investigation is required at a particular hospital or school.

### 1.4 TYPES OF HAZARDS

Since adequate literature is available on seismic, wind, flood and fire hazards, the toolkit had address all four of them.

### 1.5 DESKTOP RESEARCH

The biggest challenge in this project was to identify the area where Toolkit could be developed amidst a large number of existing books, manuals and other literature on safe Hospital and school. Majority of the existing literature in this domain were on seismic safety and primarily addressed to the technical people. Considering the shortage of time for the toolkit development, utmost care was taken to make sure that the optimum amount of documents from the best sources are examined. The Toolkits developed in this publication are heavily indebted to FEMA 577, FEMA P-424, SDMC, NSET, and other sources, which have been put up in the References.

**This is the  
School Safety Toolkit Book 2: Retro  
Maintenance: Multi-Hazard Safety Compliance**

### 1.6 PROCESS

Figure 1.1: Diagram showing steps of the toolkit development

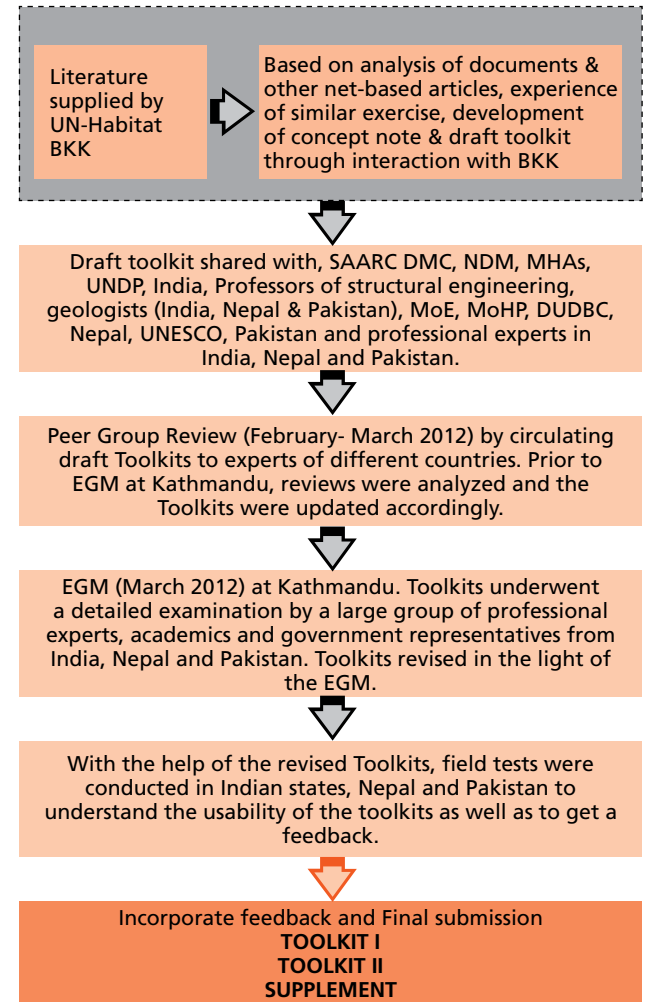

# CHAPTER 2

## 2.1 HOW TO USE THE TOOLKIT II (MULTI HAZARD RETRO-MAINTENANCE NEED ASSESSMENT OF SCHOOL)

NOTES ON HOW TO USE THE TOOLKIT II: RETROFITTING OF EXISTING SCHOOL: MULTI-HAZARD SAFETY ASSESSMENT	
THE TARGET GROUP	IT IS FOR THE EDUCATION DEPARTMENT'S TOP LEVEL MANAGEMENT (TLM), i.e.,
	LINE DIRECTOR (INFRASTRUCTURE) & TEAM
	This will enable Top Level Management to get a comprehensive idea on retrofitting needs of existing schools
	The Toolkit II enables TLM to view retrofitting and maintenance as a combined whole and screen those where detailed exam is needed
A	What does the Toolkit II do?
	The Toolkit II evaluates MULTI-HAZARD Retrofitting need of school at a particular site
	It uses a checklist to calculate the safety compliance level of schools based on a semi-objective method
B	How does the management system work?
	A cadre of trained school teachers, local science graduate youths could be formed at district level to assess retrofitting needs with Toolkit II
	The survey team will visit the site, then fill in answers against each key question of Toolkit II to evaluate its multi hazard retrofitting needs
	This Toolkit enables TLM to know the compliance index of any school. It also shows items which need retrofitting in the building and facilities
	Toolkit II will enable the TLM to screen out schools which are safe & investigate those where compliance level is below acceptable safety level ( say 0.75)
	This will be stored in computerised database of Education Ministry as a record for all future planning
	The above steps have been summarised
	in the shaded portion of Figure on the right
	Since retrofit cum maintenance is the objective,
	working process of this ToolkitII (shown in shade)
	is shown with Education department's regular
	system of maintenance data collection
	The existing maintenance data collection forms
	have been extended and a supplement has been
	designed, which has been put in Chapter on
	SUPPLEMENT
	This Toolkit + Supplement will enable the TLM &
	experts to make decisions on retro-maintenance

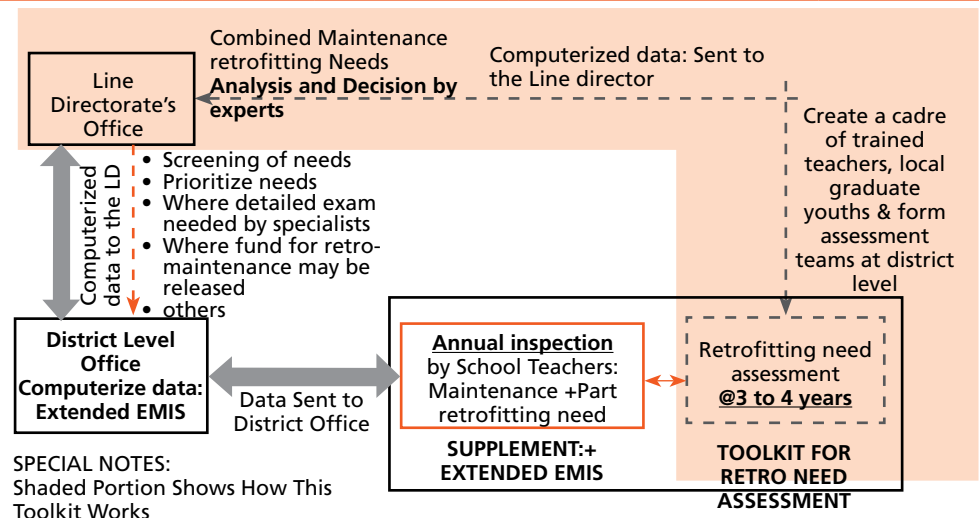

SPECIAL NOTES:  
Shaded Portion Shows How This Toolkit Works

Rest of the Figure Shows Maintenance data collection Mechanism of Ministry of Health

C									
How does a designer use the Toolkit II?									
Safety compliance of an existing building is evaluated by answering CHECKLISTs in four worksheets 1) Seismic, 2) Wind, 3) Flood, 4) Fire									
Fill in the checklists of only those hazards which are relevant your project at a particular place, e.g., in Delhi, seismic, flood and fire will be relevant									
Take a worksheet, e.g. Seismic: Go through Column B "KEY QUESTIONS..." one by one. The page looks as follows- Read the top line, it is self-explanatory									
<b>READ THIS BEFORE ANSWERING THE KEY QUESTIONS</b>									
	User will read the following key questions in this column	Against Key Question, the User will choose the appropriate answer from the given options shown in this column	<b>User's Input 1</b>	Specialists can alter scale of key question specific scoring	Specialists can change key question specific importance	DO NOT CHANGE THESE AT ALL			<b>User's Input 2:</b> Follow the instructions in column C and type in the necessary information in this column
A	B	C	D	E	F	G	H	I	J
EXPLANATORY SKETCH	KEY QUESTIONS ON SEISMIC-SAFETY OF EXISTING SCHOOL	GUIDANCE NOTES+OPTIONS FOR ANSWERS TO KEY QUESTIONS	Answer As per Guidance	Compliance Status 0-1	Issue Importance VI, I, LOW	Weighted Compliance C3XC4	Ideal Case	Compliance index	REFERENCES/REMARKS
<b>PLANNING</b>								0.22	
P1	Have you done (or referred to a) geological investigation report to know if there is an active major fault on or adjacent to the existing school site?  Special note: Consult local building department, State geologist, local university, or local geotechnical expert.	If you have done/referred to geological investigations write the source in column "REFERENCES/REMARKS" and then choose one from the following options Type "NA" if geological investigation has been referred to, which shows that the issue of fault line is not applicable in your case Type 0, if you haven't done or referred to geological investigation for your site Type 1, if the fault line is < 500m away from the site Type 2, if the fault line is between< 1000m away from the site Type 3, if the fault is > 1000m away from the site		0.75	VI	2.25	3		
			3						
The surveyor will read the key questions in columnB first. Based on the "GUIDANCE NOTES....." in Column C, surveyor will write the answer in column D									
The calculations for compliance index is done automatically									
Column E and F should not be altered by the surveyor- it is strictly for the experts only.									
Wherever instructed in the column C, the surveyor will write the requisites in column J "REFERENCES/REMARKS"									

When one completes answering all issues under one category, e.g., Planning, the Compliance Index for Planning appears in column I  
 Repeat the process of answering questions in the remaining categories, viz., Architectural, Structural and Non-structural  
 Once you have answered all five categories of worksheet "SEISMIC", proceed to the next relevant worksheets and repeat the process

**D** On completion of this process go to the last worksheet "SUMMARY" --> you will see the following chart

WRITE NA TO THOSE HAZARDS WHICH NOT RELEVANT TO YOUR SITE

HAZARD SAFETY COMPLIANCE MATRIX				
is this hazard → applicable at your site?	Applicable	Applicable	Applicable	Applicable
	MULTI HAZARD WEIGHTED COMPLIANCE			
	Seismic	Wind	Flood	Fire
Planning	0.49	NA	NA	0.38
Architectural	0.48	NA	NA	0.34
Structural	0.20	NA	NA	0.25
Non structural	0.15	NA	NA	0.17
<b>Multi Hazard compliance index</b>	<b>0.36</b>			
Overall CI	0.43	0.00	0.00	0.28
	1.00	0.00	0.00	1.00

**E** There are four specialists' control in worksheet "SUMMARY" - each country to make country-specific modifications

ISSUE IMPORTANCE SPECIALIST TO MODIFY THESE ↓ 1

VI	27
I	9
LI	3

Each key question has an importance VII/LI. Specialists to determine this to suit country specific context. Type VI/I or LI against each key question in column F of worksheet 1 to 4. These values may be modified in "SUMMARY", Table at G22

CATEGORY WEIGHT ↓ 2

0.2	Planning
0.3	Architectural
0.3	Structural
0.2	Non-structural

D14-E14-F14-G14 in "SUMMARY" calculates index based on category weight in Table at J23. Specialists may change these for each country

VI→Very Important, I→Important, LI→low importance

Compliance Index

Scale of scoring

SPECIALIST TO MODIFY THESE ↓ 3

not addressed	0
low	0.25
medium	0.5
high	0.75
1 completely addressed	1

1. the one shown in the Table of 5 options
  2. Similar linear scale with 3 to 4 options
  3. non linear variation of type 1 & 2
  4. Binary scale of "0" or "1"
- Specialists may change these pattern of scoring in column "E" of worksheet 1,2,3,4

COUNTRY SPECIFIC HAZARD WEIGHTS ↓ 4

W seis	1
Wwind	1
Wflood	1
Wfire	1

These will depend upon hazard frequency & magnitude of a country. Specialists will make country specific hazard weights in Table at J28 of "SUMMARY"



F	Final output for the Top Level Management
	When a surveyor answers all four CHECKLISTS , the compliance indexes will be automatically calculated
	Once you have filled in all the relevant worksheets, go to worksheet SUMMARY- you will see the chart on the right
	The surveyor will present this chart to the Top Level Management
	In case the compliance of a category is not 1 , the surveyor will explain the reasons as shown in the Gap Matrix shown below

Compliance Summary for the Top Level Management

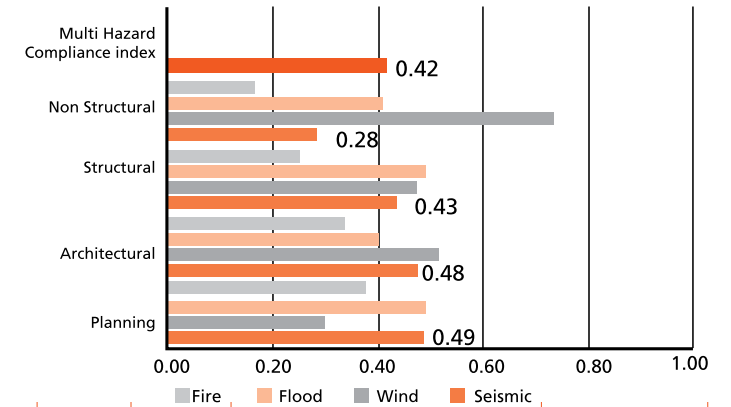

G	The following list is automatically generated showing where gaps exists. This will show where to work on to enhance the category score (planning/architectural/structural/non-structural issues)
	Special Note: The Compliance Level Cut Offs a joint decision of the TLM and the specialists- it could be modified in E39 in "SUMMARY"

TLM MAY ↓ MODIFY THIS

COMPLIANCE INDEX CUT OFF LEVEL → 1

5

MULTI HAZARD COMPLIANCE GAP MATRIX

		SEISMIC		WIND		FLOOD		FIRE	
	ISSUES	seismic compliance	ISSUES	wind compliance	ISSUES	flood compliance	ISSUES	fire compliance	
	PLANNING								
P1	Type 1, if the fault line is <500m away from the site	<u>0.15</u>	Type 5, if it is for pedestrian access only	<u>0.05</u>	Type 1, if the damage potential is low	<u>0.9</u>	Type 4, if the access road is suitable for motorbike only not for cars	<u>0.25</u>	
P2		1	Type 4 , if the probable level of wind speed reduction is < 10%	<u>0.15</u>	Type 1, if the damage potential is high	<u>0</u>	Type 3, if flow (School's exposure to external fire)	<u>0.75</u>	
P3	Type 2, Minimum effect→i.e., if some of the neighbouring buildings may collapse, however, it will have minimum impact on evacuation	<u>0.75</u>	Type 2, if falling hazards can cause damage to the school, but will not hamper its functioning	<u>0.5</u>	Type 3, if the plinth is below expected flood depth	<u>0</u>	Type 2, if there is no open space but not adequate for gathering	<u>0.5</u>	

H	<b>What is the way forward</b>
	TLM will have a computerized document on retrofitting needs of all the existing schools
	The same could be submitted to the local municipality for their record and evidence of safety
	TLM with this tool will be able to get a comprehensive idea on the nation wide pattern of retrofitting requirements & help them to focus on the critical infrastructure
	For accountability and accreditation, all private schools to submit a filled in Toolkit II showing the retrofitting need and the actions they have taken to retrofit their schools and facilities
	<b>Special Note 1</b>
	This Toolkit has considered four types of hazards. These have been adapted from different sources mentioned in the References. If needed, country/zone/area specific minor modifications could be made to this Toolkit
	However, such modifications should be done only at National level by experts and only if it is absolutely necessary
	<b>Special Note 2</b>
	This Toolkit has considered four types of hazards. However, if a country/zone/area has other types of hazards such as landslide, flash flood, etc., additional worksheets could be added to the existing Toolkit to increase its robustness
	<b>Special Note 3</b>
	A compact Disk has been attached with this toolkit which should be used to calculate the compliance index at National Level after receiving the data from all the schools. Hard copies of only the relevant hazard checklists should be sent to the schools from this Book 2 on retrofitting schools for multi-hazards
	<b>Special Note 4</b>
	The information from the "REFERENCES/REMARKS" will be of great importance. This will not only provide school specific safety gaps, it will also bring forward nationwide pattern, if any, in the context of safety at macro level. This will help in policy reforms



# CHAPTER 3

## 3.1 GENERAL INFORMATION: SCHOOL

Retrofitting of Existing School: Multi-Hazard Safety Assessment											Form Number #			
Organisation Identification Details											Mailing Details			
Key:			(Unique Code used in Organisation)					Plot No		Street /Road Name				
Name:														
Other Name:								Building Name						
								Mailing Address:						
								Town / City:						
								State/District						
								Postal code:						
Communication Details														
Telephone (Main):		(____) _____												
Tel. (Toll free):		(____) _____					Reading 1				Reading 2			
Fax:		(____) _____			GPS (S):		_____ . _____				_____ . _____			
Email Address:		_____@_____			GPS (E):		_____ . _____				_____ . _____			
Website (URL):														
Personal Contact Details of School Representative											Preferred Method of Contact:			
_____			_____			_____				Tel		Cell	Fax	Email
Title		First Name		Last Name		Designation (Job Title)								
(____) _____		(____) _____		(____) _____										
Telephone Number			Cell Number								Best time to contact you			
_____@_____														
Email Address														
Surveyor:						Date completed by:					Signed:			

Infrastructure Details (Services available)											
General Information											
		Parking:	Yes	No							
		Access Road:	Yes	No	Type:	Blacktop	Concrete	Gravel	Kutcha	any other	
			Yes	No							
	No of storeys of the building										
Total building height from ground level						meters					
	Electricity status:		Connected		Metered Supply		Solar		Generator	no supply	
	No of basements, if any		Yes	No							
	Structural system				load bearing wall	RCC frame	Steel	Shearwall system or any other			
	Water supply available:		Yes	No							
	Number of buildings:										
	Total floor area in sqm										
Total no of occupants in the building											

**PREPARE A SITE PLAN: PROPORTIONATE SKETCH: SCAN IT**

This will be done once and should be preserved.

Subsequent additions and alterations done to the campus and/or buildings will be recorded by mentioning the date.

This part may need assistance of a local level engineer/surveyor.

- v Draw the campus boundary first
- v Draw the open spaces and write on the paper such as play field, water body etc.
- v Draw the buildings and mark them as B1, B2 etc.
- v Draw the toilets T1, T2 , Drinking Water facilities DW1, DW2 and the disposal system ,
- v Write the evacuation road width
- v Draw the big trees/ transmission tower, if any, inside and near the compound

- v For each building use the format in the following pages and carryout the defect identification and recording.
- v Mark the highest observed flood water level on the wall of one of the existing buildings, if applicable

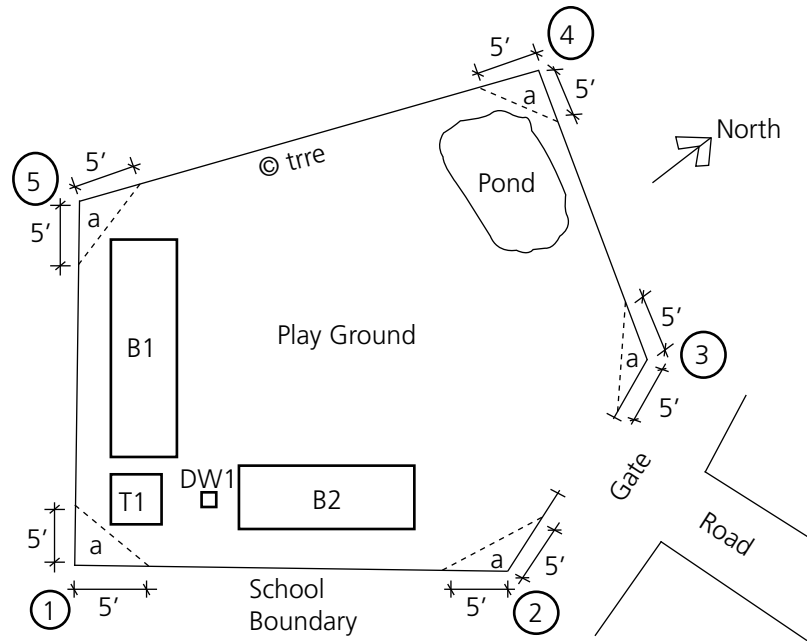

#### EXAMPLE OF SITE PLAN



- At corner 1, 2, 3, 4 and 5 mark at 5' as shown in the above figure and the measure the distance "a1, a2, a3, a4 ....." at all five corners.
- Measure 1-2, 2-3, 3-4, 4-5 and 5-1 in meters and write on the above drawing
- First measure the plinth height of B1 or B2 and mark on the drawing as shown. Take a level pipe and mark the high flood level of the plinth level. For example, if the high flood level is 600mm below the plinth, then write HFL (-600). In case the high flood level is 900mm above the plinth level then write HFL (+900)
- Write about existing use pattern of the adjacent plots

ASSET REGISTER: Record of the school facilities and their physical conditions: Use separate pages if necessary												
Facilities mark as/ site plan	No of storey	Function of the facility and no of rooms	Who constructed it	Year of construction/ age	Cost of initial construction (USD)	History of building maintenance	Type of construction methods adopted in the building				Maintenance requirements of the building **	MULTI HAZARD INDEX
							Foundation	Wall	Roof	Floor finish		
B1												
B2												
...												
**												
Type 1 if the building/ facility is in good condition - no need for maintenance,							Type 4 if the building/ facility needs major repairs, roof leakage, floor/wall cracks					
Type 2 if the building/ facility is in OK condition, need for routine maintenance,							Type 5 if the building/ facility is unsafe – to be replaced- foundation unsafe					
Type 3 if the building/ facility needs minor repair, e..g., hairline cracks												
SPECIAL NOTE: FOR EVERY BUILDING SHOWN IN THE ASSET REGISTER, CARRY OUT SAFETY COMPLAINCE												
ASSESSMENT FOLLOWING THE "USER INSTRUCTION" AND TABULATE THE MULTI HAZARD INDEX IN COLUMN "M"												

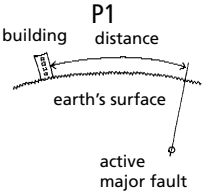

## ANNEXURE I: SEISMIC SAFETY EVALUATION: FOR EASE OF FILLING ANSWERS TO KEY QUESTIONS, ONLY THE COLUMN A,B,C,D & J HAVE BEEN SHOWN HERE

READ THIS BEFORE ANSWERING THE KEY QUESTIONS				
	User will read the following key questions in this column	Against each Key Question, the User will choose the appropriate answer from the given options shown in this column	<b>User's Input 1</b>	<b>User's input 2:</b> Follow the instructions in column C and type in the necessary information in this column
A	B	C	D	J

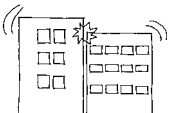
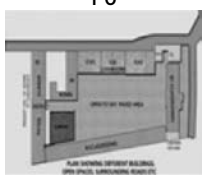

EXPLANATIONS/ SKETCHES	KEY QUESTIONS ON SEISMIC-SAFETY OF EXISTING SCHOOL	GUIDANCE NOTES + OPTIONS FOR ANSWERS TO KEY QUESTIONS	Answer As per Guidance	REFERENCES/REMARKS
PLANNING				
 <p style="text-align: center;">P1 building distance earth's surface active major fault</p>	<p>Are you aware of geological investigation report to know if there is an active major fault on or adjacent to the existing school site? Special note: Consult local building department, State geologist, local university, or local geotechnical expert.</p>	<p>If you are aware of geologic investigations write the source in column "REFERENCES/REMARKS" and then choose one from the following options Type "NA" if you geological investigation has been referred to , which shows that the issue of fault line is not applicable in your case Type 0, if you are not aware of geological investigations for your site Type 1, if the fault line is &lt; 500m away from the site Type 2, if the fault line is between 500m -1000m from the site Type 3, if the fault line is &gt;1000m away from the site</p>	3	
 <p style="text-align: center;">P2 access road ac ce ss</p> <p style="text-align: center;">Site plan showing access</p>	<p>An important aspect of safety of an existing school building is the type of access road from main road to the site of the new school</p>	<p>Depending upon the type of access road to your site choose one from the following options; Type 1, if two or more roads from mainstreet to the school, wide enough to allow one fire engine to reach, reverse and return to the mainroad Type 2, if there is one access road suitable for fire engine access &amp; movement Type 3, if access road is for cars and not fire engine Type 4, If the access road is suitable for motorbike only and not for cars Type 5, if it is for pedestrian access only</p>	5	

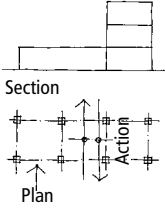
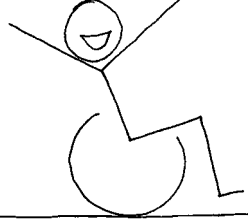
EXPLANATIONS/ SKETCHES	KEY QUESTIONS ON SEISMIC-SAFETY OF EXISTING SCHOOL	GUIDANCE NOTES + OPTIONS FOR ANSWERS TO KEY QUESTIONS	Answer As per Guidance	REFERENCES/REMARKS
<p>P3</p> <p>Collapse of buildings had blocked many access roads in the old town of Bhuj, India (earthquake, 2001). It had made rescue and relief extremely difficult</p>	<p>During earthquake, buildings along the access road to your site may collapse and block it, thus affecting post earthquake evacuation and entrance for service</p>	<p>Visit the site and visually assess the severity of impact on safe evacuation and access of services to the site immediately after an earthquake → Choose one from the following options</p> <p>Type 1, No effect→ i.e., if the existing road is wide enough and the surrounding buildings are unlikely to fall during earthquake or there is/are alternative routes to the school, unlikely to be blocked by falling buildings, power lines, etc.</p>	4	
		<p>Type 2, Minimum effect → i.e., if some of the neighbouring buildings may collapse, however, it will have minimum impact on evacuation</p>		
		<p>Type 3, Medium effect→ i.e., if part collapse may take place, however, it will have medium impact on evacuation</p>		
		<p>Type 4, Maximum effect→i.e., if possible collapse of neighbouring buildings are likely to completely block the road from evacuation</p>		
<p>P4</p> <p>Providing onsite backup for water, power gas, etc. is not adequate. They need housekeeping and periodic maintenance as well</p>	<p>Municipal supply of water is often disrupted in strong shaking. Therefore, there should be alternative source such as handpump in the school, which could be used even by the community as well, if needed</p>	<p>Alternative water source in a school increases the probability of it remaining functional immediately after disaster. Choose one from the following options</p> <p>Type 1, If in-house backup sources of water has been provided in the school</p>	0	
		<p>Type 0, If in-house backup sources of water has not been provided in the school</p>		
<p>P5</p>  <p>Buildings too close may lead to pounding</p>	<p>If your building is in Seismic Zone V,IV or III, then have you provided adequate distance from adjacent buildings or other structures from the project building to avoid pounding effect?</p>	<p>Write the distance (in meters) of the nearest building/structure from the school under consideration in column "REFERENCES/REMARKS"</p> <p>Type 1, if adequate gap has been provided to avoid pounding effect</p> <p>Type 0, if adequate gap not provided to avoid pounding effect</p>	0	
<p>P6</p>  <p>Site plan showing open space</p>	<p>Whether open space is available in the school for children to assemble during/immediately after earthquake ?</p>	<p>In the column "REFERENCES/REMARKS, write the approximate length and width of such open space and the number of students who will need it →Choose one from the following options</p> <p>Type 1, if there is adequate open space for gathering</p>	3	
		<p>Type 2, if there is open space, but not adequate for gathering</p>		
		<p>Type 3, if there is no open space for available for gathering</p>		

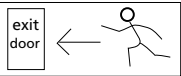
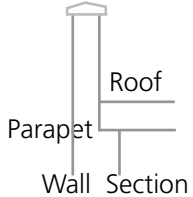
EXPLANATIONS/ SKETCHES	KEY QUESTIONS ON SEISMIC-SAFETY OF EXISTING SCHOOL	GUIDANCE NOTES + OPTIONS FOR ANSWERS TO KEY QUESTIONS	Answer As per Guidance	REFERENCES/REMARKS
<b>ARCHITECTURAL ISSUES</b>				
<p>A1</p>  <p>Plan forms such as T,L etc are irregular</p>	Is the architectural/structural configuration irregular in plan?	<p>Move in and around the building &amp; assess the level of symmetry of the building plan and then choose one from the following that is appropriate</p> <p>Type 1, if the shapes is regular, structure has uniform plan, and there are no elements that would cause twisting of building</p> <p>Type 2, if Shape is irregular but structure is uniform</p> <p>Type 3, if Shapes are irregular and structure is not uniform</p>	3	
<p>A2</p>  <p>Section Plan</p> <p>Two portions of the same building have different masses: vertical irregularity</p>	Is there vertical irregularity in architectural/structural configuration?	<p>Move in and around the building &amp; assess the level of symmetry of the building massing and then choose one from the following that is appropriate</p> <p>Type 1, if storey heights are of very similar (i.e., they differ by &lt; 5%); there are no discontinuous or irregular elements.</p> <p>Type 2, if storey heights are similar (they differ by &gt; 5% but &lt;20%) and there are few discontinuous or irregular elements;</p> <p>Type 3, if storey heights differs by &gt;20% and there are significant discontinuous or irregular elements</p>	3	
<p>A3</p>  <p>Ramps to be provided for people to be wheeled out quickly</p>	Are there provisions for physically challenged-friendly access to the buildings and functional areas?	<p>Examine the existing access routes against codes/standards, mention it in the column "REFERENCES/REMARKS Choose one from the following options</p> <p>Type 1, if the design has provision for easy evacuation of physically challenged people</p> <p>Type 2, if the existing provision for evacuation of physically challenged people is average</p> <p>Type 3, if the design is poor for evacuation of physically challenged people</p>	3	

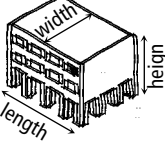
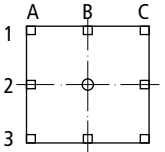
EXPLANATIONS/ SKETCHES	KEY QUESTIONS ON SEISMIC-SAFETY OF EXISTING SCHOOL	GUIDANCE NOTES + OPTIONS FOR ANSWERS TO KEY QUESTIONS	Answer As per Guidance	REFERENCES/REMARKS
<p>A4</p>  <p>Wide corridor with signage for easy evacuation in emergency</p>	<p>Is there a provision for emergency exit in the school building plan?</p>	<p>Move in and out of the building to assess if exits have been provided for easy evacuation of the occupants. Choose one option from the following</p> <p>Type 1, if one or more exit corridors of at least 2.4 meters width exists, which are well lit, easy to identify and use in emergency</p> <p>Type 2, if one or more exit corridors of width less than 2.4 m but greater than 1.2m exists, which are well lit, easy to identify and use in emergency</p> <p>Type 3, if only one corridor of less than 1.2m width exists for emergency exit</p> <p>Type 4, there is no emergency exist in design</p>	<p>4</p>	
<p>A5</p> <p>Glass must be installed in the openings with adequate space/cushioning between glass and the lintel, jambs and sill to accommodate drift of the structural system</p>	<p>Are glass and other panels fixed in openings in a way so that they will not be affected due to drift of the main structural frame during earthquake?</p>	<p>Inspect the glass &amp; other panels to know if they have safe detailing. Choose one from the following options</p> <p>Type NA, this is not applicable</p> <p>Type 1, if the existing detail of glass in openings is safe for drift of the structure</p> <p>Type 0, if the existing detail of glass in openings is not safe for drift of the structure</p>	<p>0</p>	
<p>A6</p> <p>If not fixed adequately, such tiles may come off during earthquake, making exit of the occupants unsafe or impossible</p>	<p>Are there tiles fixed on the walls particularly those surrounding exit staircases? If yes, then are those adequately fitted with bolts (or equivalent glue) for seismic safety?</p>	<p>Choose one from the following options</p> <p>Type NA, if this is not applicable</p> <p>Type 1, If the tiles are fixed to the walls with bolts or equivalent glue or other methods</p> <p>Type 0, If the tiles are not fixed to the walls with bolts or equivalent glue or other methods</p>	<p>0</p>	
<p>A7</p> <p>RCC band or equivalent as top</p> 	<p>Are parapets securely attached to the building structure to stop it from falling during earthquake?</p>	<p>Unreinforced masonry parapets are especially vulnerable if the wall top is not secured</p> <p>Type NA if there is no parapet in your building</p> <p>Type 1, if the parapet wall has a RCC band on top with vertical reinforcements anchored to the slabs at regular intervals</p> <p>Type 2, if similar arrangement as RCC band exists to stop the parapet wall from falling</p> <p>Type 3, if parapets are not restrained at all</p>	<p>3</p>	

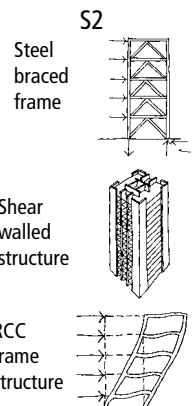
EXPLANATIONS/ SKETCHES	KEY QUESTIONS ON SEISMIC-SAFETY OF EXISTING SCHOOL	GUIDANCE NOTES + OPTIONS FOR ANSWERS TO KEY QUESTIONS	Answer As per Guidance	REFERENCES/REMARKS
<p>A8</p> 	<p>Length/breadth ratio and Height/width ratio of the existing building within permissible limit as per code?</p>	<p>Mention the code name in the column "REFERENCES/ REMARKS"</p> <p>Type 1, if the length/ breadth/ height ratios are within safe limit</p> <p>Type 2, if the length/ breadth/ height ratios are marginally out of safe limit</p> <p>Type 3, if Medium level of variation of length/ breadth/ height ratio from safe limit</p> <p>Type 4, if major variation from safe limit of length/ breadth/ height</p>	<p>4</p>	
<p>A9</p>  <p>Good example: Building plan shows that the columns are in grid lines in both directions</p>	<p>Are the walls and/or columns provided in grid lines in each direction of the plan?</p>	<p>Choose one from the following options</p> <p>Type 1, if all walls and/or columns are in grid in both directions</p> <p>Type 2, if all walls &amp;/or columns are in grid in one direction &amp; some (&lt;15%) not in grid in other direction</p> <p>Type 3, if some walls &amp;/or columns are in grid &gt;15% but &lt;25%</p> <p>Type 4, if &gt;25% of walls and/or columns are not in grid</p>	<p>4</p>	
<b>STRUCTURAL ISSUES</b>				
<p>S1</p> <p>In many places micro zoning maps may not be available. However, if it exists, the engineer must follow the micro zoning recommendations in design</p>	<p>Is the existing building safe according to the seismic micro zoning factors?</p>	<p>If Micro-Zonation map is available then mention the source in the column "REFERENCES/ REMARKS". If you feel that a rapid structural assessment by a specialist is needed mention in column "REFERENCES/ REMARKS".</p> <p>Type "NA" If Micro-Zonation map is not available and also write "not available" in the column "REFERENCES/ REMARKS"</p> <p>Type 1, if the existing building is safe as per the micro zoning recommendations</p> <p>Type 0, if the existing building is not safe as per the micro zoning recommendations</p>	<p>0</p>	

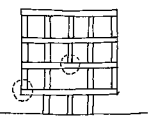
EXPLANATIONS/ SKETCHES	KEY QUESTIONS ON SEISMIC-SAFETY OF EXISTING SCHOOL	GUIDANCE NOTES + OPTIONS FOR ANSWERS TO KEY QUESTIONS	Answer As per Guidance	REFERENCES/REMARKS
<p>S2</p>  <p>Steel braced frame</p> <p>Shear walled structure</p> <p>RCC frame structure</p>	<p>Are you aware of Geotechnical set up of the areas (soil condition) &amp; have you chosen structural system based on soil type &amp; seismic zone</p> <p>If your site has soft/poor soil →</p> <p>If your site has medium soil →</p> <p>If your site has hard soil →</p>	<p>If you have information on geological setup in which your site is located, please mention the source in the column "REFERENCES/ REMARKS";</p> <p>Type 1, If the building has a light weight rigid structural system, e.g., steel braced frame, steel tube frames, etc. on pile or similar deep foundations</p> <p>Type 2 If the building is not based on structural system according to soil condition</p> <p>Type 3, If the building has a rigid structural system with short period, e.g., shear walled, steel braced, confined masonry, etc</p> <p>Type 4, If the building is not based on structural system according to soil condition</p> <p>Type 5 If the building has a flexible system with long period, e.g., RCC frame structure, base isolation, etc</p> <p>Type 6 If the building is not based on structural system according to soil condition</p>	<p></p> <p></p> <p></p> <p></p> <p></p> <p>6</p>	
<p>S3</p>  <p>Before earthquake: interlocking forces in soil particles</p> <p>During earthquake: reduced interlocking forces in soil particles</p> <p>During earthquake: when liquefaction happens</p>	<p>Was liquefaction effect considered in the existing building design- if applicable for your site?</p> <p>Soft soil that can lead to force amplification or liquefaction</p> <p>Look at the past record, drawings of the building</p>	<p>Mention the source of information on this issue regarding your site in column "REFERENCES/ REMARKS" and choose one from the following options.</p> <p>Type NA, liquifaction issue was found not applicable</p> <p>Type 1, if liquefaction is applicable and it was considered in design</p> <p>Type 2, if liquefaction is applicable and it was not considered in design</p> <p>Type 3, if neither any source of information was referred to nor the effect of liquefaction effect in design was considered</p>	<p></p> <p></p> <p></p> <p>3</p>	
<p>S4</p>  <p>Section shows that the load path of the building is discontinuous- this is not desirable</p>	<p>Is there a continuous load path from all structural components of the existing building to the foundation?</p> <p>A continuous load path enables a structure to act together as a whole when shaken. Connections from walls to floors and roofs should also form part of this load path.</p>	<p>Move in and around the building and check. If you feel that a specialist's input is needed mention in column "REFERENCES/REMARKS"</p> <p>Type 1, if the load path is continuous</p> <p>Type 2, if there is a minor deviation from the load path</p> <p>Type 3, if there is a major deviation from load path</p>	<p></p> <p></p> <p>3</p>	

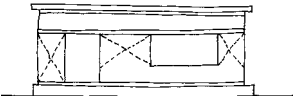
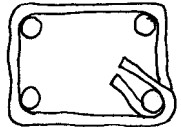
EXPLANATIONS/ SKETCHES	KEY QUESTIONS ON SEISMIC-SAFETY OF EXISTING SCHOOL	GUIDANCE NOTES + OPTIONS FOR ANSWERS TO KEY QUESTIONS	Answer As per Guidance	REFERENCES/REMARKS
<p style="text-align: center;">S5</p>  <p>For seismic safety, a masonry building should have;</p> <ol style="list-style-type: none"> <li>1. RCC bands at plinth &amp; lintel level</li> <li>2. vertical reinforcements at wall junctions &amp; on two sides of each door/ window,</li> </ol>	<p>If the school is a Masonry Structure, were vertical reinforcements &amp; horizontal bands provided in walls according to code?</p> <p>Unreinforced masonry has proven very vulnerable in strong shaking. To improve seismic performance of masonry buildings one needs to provide, reinforcements at all wall corners and RCC bands at plinth, window sill and lintel level</p>	<p>This is difficult to assess in an existing building. One has to refer to historical data, if available. Mention in cloumn "REFERENCES/ REMARKS" if you could not do this bit of inspection</p> <p>Type "NA", if it is not a masonry structure or if the inspection could not be done</p> <p>Type 1, if reinforcement at all wall corners and horizontal RCC bands at plinth and lintel levels have been provided</p> <p>Type 2, if only the RCC bands have been provided</p> <p>Type 3, if only corner reinforcments have been provided</p> <p>Type 4, If no horizontal band and vertical reinforcements provided</p>	<p style="text-align: center;">4</p>	
<p style="text-align: center;">S6</p>  <p>Ductile detail enables a structure to undergo large deformation before failure. It gives adequate warning to the occupants before failure</p>	<p>Was the reinforcement detailing done as per code to ensure ductility of the structure?</p>	<p>This is difficult to assess in an existing building. One has to refer to historical data, if available. Mention in cloumn "REFERENCES/ REMARKS" if you could not do this bit of inspection</p> <p>Type "NA", if not applicable or the inspection could not be done</p> <p>Type 1, of ductile detailing has been adopted as per codes</p> <p>Type 2, if ductile detailing is partially done</p> <p>Type 3, if ductile detailing has not been done as per code</p>	<p style="text-align: center;">3</p>	
<p style="text-align: center;">S7</p> <p>It is mandatory to consider seismic force on a building if it is in earthquake prone area. There are codes on seismic safety, e.g., IS 1893,2002 (Indian Code)</p>	<p>Was seismic load considered in the building design?</p>	<p>This is difficult to assess in an existing building. One has to refer to historical data, if available. Mention in cloumn "REFERENCES/ REMARKS" if you could not do this bit of inspection</p> <p>Type NA if you could not ascertain this</p> <p>Type 1, If sesimic load has been considered in design</p> <p>Type 0, If sesimic load has not been considered in design</p>	<p style="text-align: center;">0</p>	

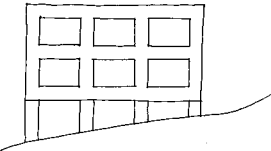
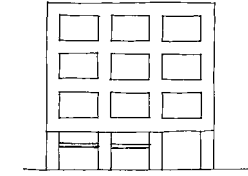
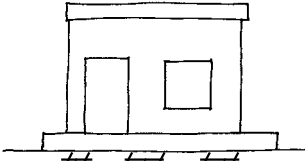
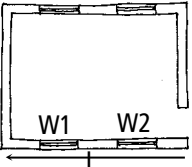

EXPLANATIONS/ SKETCHES	KEY QUESTIONS ON SEISMIC-SAFETY OF EXISTING SCHOOL	GUIDANCE NOTES + OPTIONS FOR ANSWERS TO KEY QUESTIONS	Answer As per Guidance	REFERENCES/REMARKS
<p>S8</p> <p>Different column heights: building on slope</p>  <p>Different column heights: mezzanine</p> 	<p>Was Short column effect been considered in structural analysis and design?</p> <p>Special note: short columns attract more seismic load than tall columns. In framed structure, short column effect may be highly detrimental and hence, such effect must be considered in design</p>	<p>This is difficult to assess in an existing building. One has to refer to historical data, if available. Mention in cloumn "REFERENCES/ REMARKS" if you could not do this bit of inspection</p> <p>Type "NA", if not applicable or the inspection could not be done</p> <p>Type 1, if short column effect considered in the structure?</p> <p>Type 0, if short column effect not considered in the structure?</p>	<p>0</p>	
<p>S9</p>  <p>In masonry buildings, these should be at least 600mm</p>	<p>For Masonry buildings, the locations of doors &amp; windows are very important. Check if they are as per safety</p> <p>If not followed, there could be severe damage to the building</p>	<p>Each door or window should be at lease 600mm away from wall corners. The space between two openings should also be at least 600mm. Choose one from the following options</p> <p>Type "NA", if not a masonry building</p> <p>Type 1, if doors, windows are at least 600mm away from wall corner and there is at least 600mm wide wall between two openings</p> <p>Type 0, if doors, windows are not 600mm away from wall corner and/or there is &lt; 600mm wide wall between two openings</p>	<p>0</p>	
<p>S10</p>  <p><math>W1 + W2 \leq 0.5L</math></p>	<p>Check if the total width of doors and windows in a wall is <math>\geq</math> half the total wall length</p> <p>If this is is not followed, there will be possibility of sliding of the portion of the wall above window sill</p>	<p>Add the door and window widths on a wall and check if it is <math>&gt;</math> the wall length. Choose one from the following</p> <p>Type "NA", if not a masonry building</p> <p>Type 1, If total door+window width in a wall is <math>&lt;</math> its wall length &amp; this is true for all walls of the building</p> <p>Type 0, If total door+window width in a wall is <math>&gt;</math> its wall length</p>	<p>0</p>	

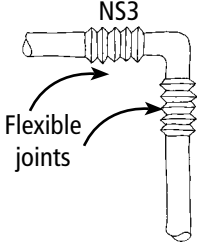
EXPLANATIONS/ SKETCHES	KEY QUESTIONS ON SEISMIC-SAFETY OF EXISTING SCHOOL	GUIDANCE NOTES + OPTIONS FOR ANSWERS TO KEY QUESTIONS	Answer As per Guidance	REFERENCES/REMARKS
	<b>NON STRUCTURAL ISSUES</b>			
<p><b>NS1</b></p> <p>During earthquake plumbing lines may break and rooftop water tanks may topple leaving no water for drinking</p>	Are plumbing lines, rooftop/overhead water tank safely placed and anchored adequately	<p>If there is no water supply then mention it in column "REFERENCES/REMARKS"</p> <p>Type 1, if plumbing lines &amp; rooftop/overhead water tank are adequately supported &amp; secured or there is a hand pump</p> <p>Type 0, if plumbing lines &amp; rooftop/overhead water tank are not supported &amp; secured or there is no water supply</p>	0	
<p><b>NS2</b></p> <p>During earthquake fire protection lines may break leaving no water for fire fighting</p>	Is fire protection piping correctly installed and braced?	<p>If fire protection piping does not exist, mention this in the column "REFERENCES/REMARKS". Choose one from the following options</p> <p>Type "NA", if fire protection piping does not exist</p> <p>Type 1, if fire protection piping correctly installed and braced</p> <p>Type 0, if fire protection piping not correctly installed and braced</p>	0	
<p><b>NS3</b></p>  <p>Flexible joints</p>	Are gas lines to laboratories provided with flexible connection? Otherwise they can cause dangerous leaks & may cause fire	<p>If there is no lab in the school, mention this in the column "REFERENCES/REMARKS" → Choose one from the following options</p> <p>Type "NA", if there is no lab.</p> <p>Type 1, if you have provided flexible joints and the lines are clamped at suitable points</p> <p>Type 0, if you have not provided flexible joints and the lines clamped at suitable points</p>	0	
<p><b>NS4</b></p> <p>This could be a falling hazard</p>	Are suspended lighting fixtures securely attached, braced, or designed to stop sideways movement?	<p>Choose one from the following options. If suspended lighting fixtures do not exist, mention this in the column "REFERENCES/REMARKS"</p> <p>Type "NA", if suspended lighting fixtures do not exist</p> <p>Type 1, if suspended lighting fixtures are securely attached and braced</p> <p>Type 0, if suspended lighting fixtures are not securely attached and braced</p>	0	
<p><b>NS5</b></p> <p>The generator, batteries, and other electrical equipment may slide/topple during earthquake, if not designed adequately</p>	Is generator and associated equipment secured against movement during earthquake?	<p>Have these been secured against movement? If emergency generator does not exist, mention this in the column "REFERENCES/REMARKS"</p> <p>Type "NA", if emergency generator does not exist</p> <p>Type 1, if emergency generator etc. are secured against movement</p> <p>Type 0, if emergency generator etc. are not secured against movement</p>	0	

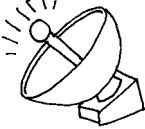
EXPLANATIONS/ SKETCHES	KEY QUESTIONS ON SEISMIC-SAFETY OF EXISTING SCHOOL	GUIDANCE NOTES + OPTIONS FOR ANSWERS TO KEY QUESTIONS	Answer As per Guidance	REFERENCES/REMARKS
<p>NS6</p> <p>Make sure that the anchorage, bracing and connections are adequate against horizontal force</p>	<p>Is fire alarm equipment secured against movement? Equipment can slide or topple, breaking connections.</p>	<p>if there is no fire alarm equipment in the school, mention this in the column "REFERENCES/REMARKS" Choose one from the following options</p> <p>Type "NA", if there is no fire alarm equipment</p> <p>Type 1, if fire alarm equipment is secured against movement</p> <p>Type 0, if fire alarm equipment not secured against movement</p>	<p>0</p>	
<p>NS7</p>  <p>Communication antenna: make sure that the anchorage, bracing and connections are adequate against horizontal force</p>	<p>Are communications components, including antennas, adequately secured for seismic forces?</p>	<p>if there is no such equipment in the school, mention this in the column "REFERENCES/REMARKS" Choose one from the following options</p> <p>Type "NA", if there is no such equipment</p> <p>Type 1, if communications components, including antennas are adequately connected and supported</p> <p>Type 0, if communications components, including antennas are not connected and supported</p>	<p>0</p>	

## ANNEXURE II: WIND SAFETY EVALUATION: FOR EASE OF FILLING ANSWERS TO KEY QUESTIONS, ONLY THE COLUMN A,B,C,D & J HAVE BEEN SHOWN HERE

READ THIS BEFORE ANSWERING THE KEY QUESTIONS				
	User will read the following key questions in this column	Against each Key Question, the User will choose the appropriate answer from the given options shown in this column	<b>User's Input 1</b>	<b>User's input 2:</b> Follow the instructions in column C and type in the necessary information in this column
A	B	C	D	J

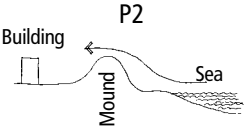
EXPLANATIONS/ SKETCHES	KEY QUESTIONS ON WIND-SAFETY OF EXISITING SCHOOL	GUIDANCE NOTES + POSSIBLE ANSWERS TO KEY QUESTIONS	Answer As per Guidance	REFERENCES/REMARKS
	<b>PLANNING</b>			
<p style="text-align: center;">P1</p>  <p style="text-align: center;">Site plan showing access roads</p>	<p>An important aspect of safety of a building is the type of access road from the main road to the site of the new school</p>	<p>Depending upon the type of access road to your site, choose one from the following options;</p> <p>Type 1, if two or more roads from mainstreet to building, wide enough to allow one fire engine to reach, reverse and return to the mainroad</p> <p>Type 2, if there is one access road of the above type</p> <p>Type 3, if access road is for cars and not fire engine</p> <p>Type 4, If the access road is suitable for motorbike only and not for cars</p> <p>Type 5, if it is for pedestrian access only</p>		
<p style="text-align: center;">P2</p>  <p style="text-align: center;">The mound reduces wind load on the building from the sea side</p>	<p>Will the surrounding landscape and topography reduce wind speed on your building?</p>	<p>Based on historical data and community experience judge this issue. Mention the source of information in column "REFERENCES/REMARKS", if referred to</p> <p>Type 1 , if the probable level of wind speed reduction is &gt; 50%</p> <p>Type 2 , if the probable level of wind speed reduction is &gt; 25% but &lt;50%</p> <p>Type 3 , if the probable level of wind speed reduction is &gt; 10% but &lt;25%</p> <p>Type 4 , if the probable level of wind speed reduction is &lt; 10%</p>		

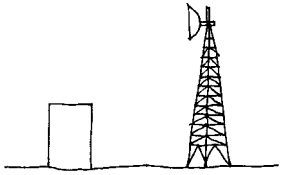
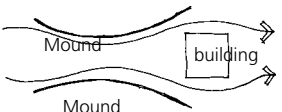
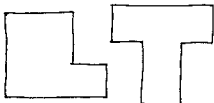
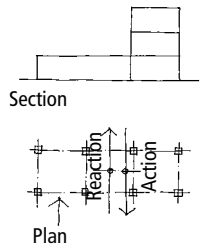
EXPLANATIONS/ SKETCHES	KEY QUESTIONS ON WIND-SAFETY OF EXISITING SCHOOL	GUIDANCE NOTES + POSSIBLE ANSWERS TO KEY QUESTIONS	Answer As per Guidance	REFERENCES/REMARKS
<p>P3</p>  <p>Tower too close to the building</p>	<p>Are there trees and/or towers too close to the building that may fall on it during high wind/cyclone?</p>	<p>Depending upon the type of falling hazards at your site, choose one from the following options            Type 1, if falling hazards can stop the school from functioning            Type 2, if falling hazards can cause damage to the school, but will not hamper its functioning            Type 3, if there is no threat of falling of trees/towers, etc</p>	<p>3</p>	
<p>P4</p>  <p>Plan showing wind tunnel effect on building</p>	<p>Is there a potential wind tunnelling effect at site due to the surrounding topography and/or adjacent buildings and structures</p>	<p>Choose one from the following options            Type NA, if wind tunnelling effect does not exist            Type 1, if wind tunnelling effect exists and you have considered it in design            Type 0, if wind tunnelling effect exists but you did/ could not consider it in design</p>	<p>0</p>	
<b>ARCHITECTURAL ISSUES</b>				
<p>A1</p>  <p>Plan forms such as T,L etc are irregular</p>	<p>Is the architectural/structural configuration irregular in plan?</p>	<p>Move in and around the building &amp; assess the level of symmetry of the building plan and then choose one from the following that is appropriate            Type 1, if Shapes are regular, structure has uniform plan, and there are no elements that would cause torsion            Type 2, if Shapes are irregular but structure is uniform;            Type 3, if Shapes are irregular and structure is not uniform</p>	<p>3</p>	
<p>A2</p>  <p>Two portions of the same building have different masses: vertical irregularity</p>	<p>Is there vertical irregularity in architectural/ structural configuration?</p>	<p>Move in and around the building &amp; assess the level of symmetry of the building massing and then choose one from the following that is appropriate            Type 1, if storey heights are of very similar (i.e., they differ by &lt; 5%); there are no discontinuous or irregular elements.            Type 2, if storey heights are similar (they differ by &gt; 5% but &lt;20%) and there are few discontinuous or irregular elements;            Type 3, if storey heights differs by &gt;20% and there are significant discontinuous or irregular elements</p>	<p>3</p>	

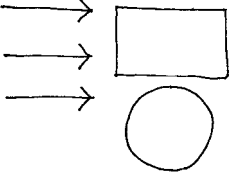
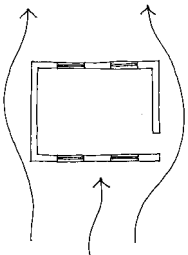
EXPLANATIONS/ SKETCHES	KEY QUESTIONS ON WIND-SAFETY OF EXISTING SCHOOL	GUIDANCE NOTES + POSSIBLE ANSWERS TO KEY QUESTIONS	Answer As per Guidance	REFERENCES/REMARKS
<p>A3</p>  <p>Uniform shapes presenting minimum obstruction to the wind</p>	<p>Does the building have a uniform shape presenting minimum obstruction to the wind</p>	<p>How does your building feature in this context? Choose one from the following options</p> <p>Type 1, if regular in plan and masing</p> <p>Type 2, if regular in plan and irregular in massing</p> <p>Type 3, if both plan and massing are irregular</p>		
<p>A4</p> <p>If you know the geo-climatic conditions of the site based on historical data, it is best to orient the building to face the least wind force.</p>	<p>Is the building suitably oriented considering the prevailing wind direction</p>	<p>In terms of orientation of the building what is your assessment on probable performance against wind forces</p> <p>Type 1, if good (building suitably oriented considering the prevailing wind direction)</p> <p>Type 2, if medium (building more or less suitably oriented considering the prevailing wind direction)</p> <p>Type 3, if low (building not really oriented considering the prevailing wind direction)</p> <p>Type 4, if very low (building not oriented considering the prevailing wind direction)</p>		
<p>A5</p> <p>It is important to have latches located for easy manoeuvring during high wind</p>	<p>Do the door and windows have a good and accessible latch?</p>	<p>Choose one from the following options</p> <p>Type 1, if both doors and windows have accessible and good latches</p> <p>Type 2, if some of the doors &amp; windows have accessible and good latches</p> <p>Type 3 if niether doors or windows have accessible and good latches</p>		
<p>A6</p>  <p>Plan showing balanced opening on opposite walls</p>	<p>Is there a balance of the size of openings on opposite walls</p>	<p>Choose one from the following options</p> <p>Type 1, if good balance of the size of openings on opposite walls</p> <p>Type 2, if medium balance of the size of openings on opposite walls</p> <p>Type 3, if low balance of the size of openings on opposite walls</p> <p>Type 4, if very low balance of the size of openings on opposite walls</p>		

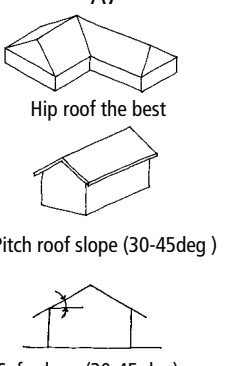

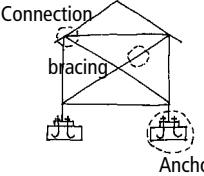
EXPLANATIONS/ SKETCHES	KEY QUESTIONS ON WIND-SAFETY OF EXISTING SCHOOL	GUIDANCE NOTES + POSSIBLE ANSWERS TO KEY QUESTIONS	Answer As per Guidance	REFERENCES/REMARKS
<p>A7</p> 	<p>Have you used a pitch or hip roof?</p> <p>Roof pitch between 30-45 deg to minimize suction caused by negative pressure</p>	<p>Hip roofs have the best record of resistance, the next best is gable roof with a pitch of 30-450 , low gable roof and flat roof have the worst record</p> <p>Type NA, if not applicable</p> <p>Type 1, if you have used a hip roof of slope &gt; 20deg</p> <p>Type 2, if you have used a pitch roof and the slope is 30-450</p> <p>Type 3, if you have used a pitch roof and the slope is 20-290</p> <p>Type 4, if you have used a pitch roof and the slope is &lt;190</p>	4	
<p>A8</p> <p>Ideally the entire building should be safe from missiles/debris. If not, then a few enclosures should be designed as shelter for the occupants during cyclone/high wind</p>	<p>In places where missile/debris are highly likely to pound on a building, then have you built an enclosure to provide debris protection?</p>	<p>This is difficult to asses. The surveyor has to go by visual judgement in this regard and also, if possible, refer to historical data</p> <p>Type "NA" if missile/debris are not likely to pound on the building</p> <p>Type 1 , if missile/debris are highly likely to pound on a building, iand there is an enclosure to provide debris protection?</p> <p>Type 0 , if missile/debris are highly likely to pound on a building, and there is no enclosure to provide debris protection?</p>	0	
<p>A9</p> <p>Suitable detail should be made to make sure that the storm shutter does not hamper easy handling of the glass shutters in normal circumstances</p>	<p>In case there is a possibility of occurrence of missile, have you provided storm shutters to protect the glass panes of the windows and openings?</p>	<p>Choose one from the following options</p> <p>Type "NA" if not applicable in your case</p> <p>Type 1, if building is in missile prone area and you have provided storm shutters</p> <p>Type 0, if building is in missile prone area and you have not provided storm shutters</p>	0	

EXPLANATIONS/ SKETCHES	KEY QUESTIONS ON WIND-SAFETY OF EXISITING SCHOOL	GUIDANCE NOTES + POSSIBLE ANSWERS TO KEY QUESTIONS	Answer As per Guidance	REFERENCES/REMARKS
	<b>STRUCTURAL ISSUES</b>			
S1 The engineer should take account of the local conditions such as wind tunneling effect, obstructions reducing wind speed, etc.	Was the design wind speed considered at the site along with a) building height, b)width, c) height and d) topographic features? (e.g., IS 875 Part 3, 1987: $V_z \rightarrow$ design wind speed, $k_1 \rightarrow$ risk co-efficient, $k_2 \rightarrow$ terrain, height & size factor & $k_3$ topography factor)	If there is no information on design, mention in column "REFERENCES/REMARKS". If in high wind zone (e.g., coastal area) recommend specialists' assessment in column "REFERENCES/REMARKS". Type 1, if design wind speed was considered along with a)building height, b)width, and c)risk, terrain and topographic features Type 0, if design wind speed was not considered along with a)building height, b)width, and c)risk, terrain and topographic features	0	
S2 Engineers should be careful about the presence of such walls since one might overlook this important issue in the complex process of analysis of the main structural system	Are there interior non-load-bearing walls? Unreinforced brick, concrete, and other types of masonry walls are vulnerable in wind load	If there is no information on design, mention in column "REFERENCES/REMARKS". If in high wind zone (e.g., coastal area) recommend specialists' assessment in column "REFERENCES/REMARKS". Type "NA" if not applicable in your case Type 1, if interior non-load-bearing walls have been designed for wind Type 0, if interior non-load-bearing walls have not been designed for wind	0	
S3  ABC (anchorage, bracing and connection)- three prerequisites for wind safety	Have you considered A, B & C (anchorage, bracing, connection) of safety in your design?  Make sure of strong fixings and joints between all elements: foundations- walls-cladding walls-roof frame-coverings. cross bracing, anchor, connections. reinforce vertical and horizontal diagonal bracing (triangulation)	If there is no information on design, mention in column "REFERENCES/REMARKS". If in high wind zone (e.g., coastal area) recommend specialists' assessment in column "REFERENCES/REMARKS". Type 1, if all A,B,C were considered in design detailing Type 2, if two out of A,B,C were considered in design detailing Type 3, if only one out of A,B,C has been considered in design detailing Type 4, if none of A, B, C were considered in design detailing	4	
S4 Wind-borne debris can cause injury to the people during high wind.	Is there a covered walkway for building to building connection? Wind-borne debris can cause injury to the people during high wind.	Choose one from the following options based on visual inspection Type 1, if there is a covered walkway which is designed for debris Type 2, if there is a covered walkway which has not been designed for debris Type 3, if there is no covered walkway	3	

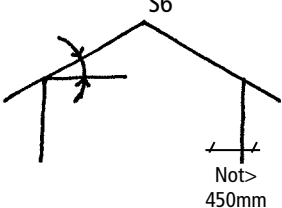
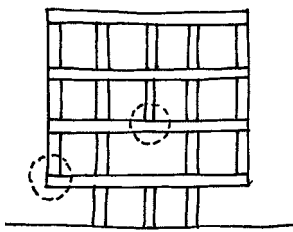

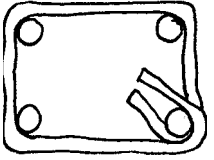
EXPLANATIONS/ SKETCHES	KEY QUESTIONS ON WIND-SAFETY OF EXISTING SCHOOL	GUIDANCE NOTES + POSSIBLE ANSWERS TO KEY QUESTIONS	Answer As per Guidance	REFERENCES/REMARKS
<p>S5</p> <p>For large span structures such as gymnasium, auditorium, etc., one should consider the wind uplift forces in design and detailing</p>	<p>Do portions of the existing facility have long-span roof structures (e.g., a gymnasium)?</p>	<p>If there is no information on design, mention in column "REFERENCES/REMARKS". If in high wind zone (e.g., coastal area) recommend specialists' assessment in column "REFERENCES/REMARKS".</p> <p>Type "NA" if not applicable in your case</p> <p>Type 1, if large span exists and designed for structural strength for wind uplift resistance</p> <p>Type 0, if large span exists and not designed for structural strength for wind uplift resistance</p>	<p>0</p>	
<p>S6</p>  <p>Not &gt; 450mm</p> <p>If the overhang is &gt;450mm one needs to design for wind uplift</p>	<p>Are there existing roof overhangs that cantilever &gt; 450mm?</p>	<p>Overhangs on buildings often have inadequate uplift resistance.</p> <p>Type NA, If not applicable</p> <p>Type 1, If it is applicable in your case and if safe in wind uplift</p> <p>Type 0, If it is applicable in your case and if not safe in wind uplift</p>	<p>0</p>	
<p>S7</p>  <p>Section shows that load path of the building is discontinuous- this is not desirable</p>	<p>Is there a continuous load path from all components of the building to the foundation?</p> <p>A continuous load path enables a structure to act together as a whole when subjected to dynamic force. Connections from walls to floors and roofs should also form part of this load path.</p>	<p>Go in &amp; around the building &amp; check &amp; choose one from the following options. If in high wind zone (e.g., coastal area) may recommend specialist's intervention (mention in column "REFERENCES/REMARKS")</p> <p>Type 1, if the load path is continuous</p> <p>Type 2, if there is a minor deviation from the load path</p> <p>Type 3, if there is a major deviation from the load path</p>	<p>3</p>	
<p>S8</p> <p>The critical areas are the J bolt connections at the ridge line, hip lines, etc</p>	<p>Is it made sure that the roof covering elements such as tiles, corrugated galvanized iron sheets, etc., cannot be lifted off by wind</p>	<p>Choose one from the following options</p> <p>If not applicable type in "NA"</p> <p>Type 1, designed &amp; detailed roof covering is safe against wind uplift</p> <p>Type 0, not designed &amp; detailed roof covering is safe against wind uplift</p>	<p>0</p>	

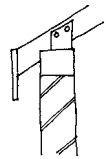
EXPLANATIONS/ SKETCHES	KEY QUESTIONS ON WIND-SAFETY OF EXISTING SCHOOL	GUIDANCE NOTES + POSSIBLE ANSWERS TO KEY QUESTIONS	Answer As per Guidance	REFERENCES/REMARKS
S9 Choice of materials and detailing are crucial	Are existing exterior walls resistant to wind-borne debris?	If the building is in a cyclone/high wind-prone region, consider enhancing debris resistance, particularly in detailing. Carryout a visual inspection If not applicable type in "NA" Type 1, if designed and detailed to make the existing exterior walls resistant to wind-borne debris Type 0, if not designed and detailed to make the existing exterior walls resistant to wind-borne debris	0	
S10  Ductile detail enables a structure to undergo large deformation before failure. It gives adequate warning to the occupants before failure	Was the reinforcement detailing as per code to ensure ductility the structure?	assessment in this regard is not possible unless there is available design and drawing. Whether available or not mention this in the column "REFERENCES/REMARKS" Type 1, of all reinforcements are designed & detailed for ductility as per codes Type 2, reinforcements are not designed & detailed for ductility as per codes Type 3, no information is available in this regard	3	
<b>NON STRUCTURAL ISSUES</b>				
NS1 Material specification and detailing are crucial	Are the hinges, wind stays, latches, handles and bolts designed to ensure easy and low maintenance intensive openings that can be closed quickly	Choose one from the following options Type 1, if the design and detailing of hinges, wind stays, latches, handles and bolts of openings suitable for high wind Type 0, if the design and detailing of hinges, wind stays, latches, handles and bolts of openings not suitable for high wind	0	
NS2 Material specification and detailing are crucial	Were the exterior doors, windows, and skylights designed and detailed for high wind?	Are the selected materials and systems, and detailing suitable to resist wind and wind-driven rain Type NA if not applicable Type 1, if selected materials and systems, and detailing suitable to resist wind and wind-driven rain Type 0, if selected materials and systems, and detailing not suitable to resist wind and wind-driven rain	0	
NS3 Roof sheets, tiles, coconut, flower pots, garbage bins, small stones, etc., could act as missiles	Damage to windows, doors and other openings are commonly caused by missiles (roof sheets, tiles, coconut, flower pots, garbage bins, small stones, etc). If the building is in such zone, then were this considered in design?	Have you selected materials and systems, and detailed to resist missiles/debris? If not applicable type in "NA" Type 1, if designed and detailed doors & windows for missile Type 0, if not designed and detailed doors & windows for missile	0	

EXPLANATIONS/ SKETCHES	KEY QUESTIONS ON WIND-SAFETY OF EXISTING SCHOOL	GUIDANCE NOTES + POSSIBLE ANSWERS TO KEY QUESTIONS	Answer As per Guidance	REFERENCES/REMARKS
<p>NS4</p> <p>It is very important that you also consider the effect of thermal expansion and contraction related deterioration of the connection?</p>	Are there tiles, veneer or stucco as exterior claddings? If applicable then are the attachments safe against wind?	<p>Choose one from the following options</p> <p>If not applicable--&gt; "NA"</p> <p>Type 1, if the effect of high wind considered while selecting materials and detailing the joint</p> <p>Type 0, if the effect of high wind not considered while selecting materials and detailing the joint</p>	0	
<p>NS5</p> <p>If not held down adequately, tiles may be blown off by high wind</p>	Does the roof have surfacing with tiles, or insulation boards? Are the tiles safe in high wind?	<p>If applicable, is it safe in the wind blow off effect?</p> <p>If not applicable --&gt; "NA"</p> <p>Type 1, if surface tiles, or insulation boards safe in the wind blow off effect</p> <p>Type 0, if surface tiles, or insulation boards not safe in the wind blow off effect</p>	0	
<p>NS6</p>  <p>Consider wind blow off effect while designing the flashing or coping</p>	Does the existing roof have edge flashing or coping? Is it safe in high wind?	<p>If applicable, are the design and detailing safe in wind blow off effect?</p> <p>Type "NA", If not applicable</p> <p>Type 1, if safe in wind blow off effect in design and detailing of edge flashing or coping of existing roof</p> <p>Type 0, if not safe in wind blow off effect in design and detailing of edge flashing or coping of existing roof</p>	0	
<p>NS7</p>  <p>Communication antenna: make sure that the anchorage, bracing and connections are adequate against horizontal force</p>	Are there antennae (communication masts) or satellite dishes anchored with structural part?	<p>If yes, then are the design of the installations, ties, etc. safe for wind resistance?</p> <p>Type "NA", If not applicable</p> <p>Type 1, if the antennae (communication masts) or satellite dishes, ties, etc. safe for wind resistance</p> <p>Type 0, if the antennae (communication masts) or satellite dishes, ties, etc. not safe for wind resistance</p>	0	
<p>NS8</p> <p>Roof sheets, tiles, coconut, flower pots, garbage bins, small stones, etc., could act as debris</p>	Is the emergency generator(s) housed in a wind- and debris-resistant enclosure?	<p>If applicable is it built in an enclosure to provide debris protection?</p> <p>Type "NA", If not applicable</p> <p>Type 1, if an enclosure exists to provide debris protection for the emergency generators</p> <p>Type 0, if an enclosure does not exist to provide debris protection for the emergency generators</p>	0	

## ANNEXURE III: FLOOD SAFETY EVALUATION: FOR EASE OF FILLING ANSWERS TO KEY QUESTIONS, ONLY THE COLUMN A, B, C, D & J HAVE BEEN SHOWN HERE

R E A D T H I S B E F O R E A N S W E R I N G T H E K E Y Q U E S T I O N S				
	User will read the following key questions in this column	Against each Key Question, the User will choose the appropriate answer from the given options shown in this column	<b>User's Input 1</b>	<b>User's input 2:</b> Follow the instructions in column C and type in the necessary information in this column
A	B	C	D	J
EXPLANATIONS/ SKETCHES	KEY QUESTIONS ON FLOOD-SAFETY OF EXISTING SCHOOL	GUIDANCE NOTES + POSSIBLE ANSWERS TO KEY QUESTIONS	Answer As per Guidance	REFERENCES/REMARKS
	<b>PLANNING</b>			
<p>P1 In coastal communities, even sites at some distance inland from the shoreline may be exposed to extreme storm surge flooding.</p>	<p>Is the site located in a storm surge inundation zone (or tsunami inundation area)? In coastal communities, even sites at some distance inland from the shoreline may be exposed to extreme storm surge flooding.  If yes, then, make an assessment on damage potential due to storm surge based on historical data- consult the meteorology departments</p>	Storm surge maps may be available at State or local emergency management offices. Mention in the column "REFERENCES/ REMARKS" whether it is available or not available		
		Type "NA", If you have referred to the map and found your site not in such zone		
		Type 1, if the damage potential is low		
		Type 2, if the damage potential is medium		
<p>P2 Consult local people for historical data- also consult the state geology department</p>	<p>Is the site located in a zone with possible water surge from glacial lake/lake caused by land slide or due to earthquake</p>	Mention the source in column "REFERENCES/ REMARKS" if you have referred to any document or department→ Choose one from the following options		
		Type "NA" if not applicable		
		Type 1, if the damage potential is high		
		Type 0, if the damage potential is very low	0	
<p>P3 Refer to historical data for a safe decision</p>	<p>What is the expected level of inundation at the site? i.e., expected maximum flood elevations with respect to the plinth level of the building, e.g., the score will be high if the maximum flood elevation is 300mm below the plinth level.</p>	Mention the max. flood level (+/-) in mm with respect to the plinth level in the column "REFERENCES/ REMARKS" → Choose one from the following options		
		Type 1, if the plinth is atleast 300mm above the maximum inundation level		
		Type 2, if the plinth is atleast 150mm above the maximum inundation level		
		Type 3, if the plinth is below expected flood depth	3	

EXPLANATIONS/ SKETCHES	KEY QUESTIONS ON FLOOD-SAFETY OF EXISTING SCHOOL	GUIDANCE NOTES + POSSIBLE ANSWERS TO KEY QUESTIONS	Answer As per Guidance	REFERENCES/REMARKS
<p>P4</p> <p>Duration has bearing on the stability of earthen fills, access to a site and emergency response and durability of materials that come into contact with water. Records of actual flooding are the best indicator of duration as most floodplain analyses do not examine duration.</p>	<p>What is the potential damage level due to the expected duration of flooding?</p>	Mention the duration of flooding in column "REFERENCES/REMARKS" what is the damage potential due to stagnation of flood water		
		If not applicable -->"NA"		
		Type 1, if damage potential is low in expected duration of flooding		
		Type 2, if damage potential is medium in expected duration of flooding		
		Type 3, if damage potential is high in expected duration of flooding	3	
<p>P5</p> <p>Although dam failure generally is considered an unlikely event, the potential threat should be evaluated due to the catastrophic consequences.</p>	<p>Is the site in an area predicted to be inundated if an upstream dam were to fail?</p>	Choose one from the following options		
		If not applicable -->"NA"		
		Type 1, if potential threat of upstream dam failure is very low		
		Type 2, if potential threat of upstream dam failure is medium		
		Type 3, if potential threat of upstream dam failure is high	3	
<p>P6</p> <p>If areas with poor local drainage and frequent flooding cannot be avoided, filling, regrading, and installation of storm drainage facilities may be required.</p>	<p>Does the surrounding topography contribute to flooding at the site? Is there a history of local surface drainage problems due to inadequate site drainage?</p>	Mention in the column "REFERENCES/REMARKS" if such incidences have happened in the past also mention the severity of such flooding		
		If not applicable -->"NA"		
		Type 1, if low chance of surrounding topography contributing to flooding		
		Type 2, if medium chance of surrounding topography contributing to flooding		
		Type 3, if high chance of surrounding topography contributing to flooding	3	
<p>P7</p> <p>Access is increasingly important as the duration of flooding increases. For the safety of occupants, most critical facilities should not be occupied during flood events.</p>	<p>Is at least one access road to the site/building passable during flood events?</p>	choose one from the following options		
		Type 1, if at least one access road to the site/building is passable during flood events		
		Type 0, if no access road to the site/building is passable during flood events	0	

EXPLANATIONS/ SKETCHES	KEY QUESTIONS ON FLOOD-SAFETY OF EXISTING SCHOOL	GUIDANCE NOTES + POSSIBLE ANSWERS TO KEY QUESTIONS	Answer As per Guidance	REFERENCES/REMARKS
	<b>ARCHITECTURAL ISSUES</b>			
A1 New critical facilities built in flood hazard areas should not have any functions occupying flood-prone spaces (other than parking, building access, and limited storage)	Are any critical building functions occupying space that is below the elevation of the past record of flood or the Design Flood Elevation?	Choose one from the following options Type NA, If not applicable Type 1, if critical functions could be relocated to upper levels that are above predicted flood elevations Type 2, if critical functions cannot be relocated, but flood proofing could be done Type 3, if critical functions cannot be relocated, neither flood proofing could be done	3	
A2 These issues should be addressed right at the schematic design level by the architect	If critical functions must continue during a flood event, have power, supplies, and access issues been addressed?	Choose one from the following options Type NA, If not applicable Type 1, completely addressed (critical functions can continue during a flood event with power, supplies, and access) Type 2, partly addressed (critical functions can partially continue during a flood event with power, supplies, and access) Type 3, not addressed at all (critical functions cannot continue during a flood event with power, supplies, and access)	3	
A3 If critical contents cannot be permanently located on higher floors, a flood response plan should take into account the time and attention needed to move such contents safely.	Have critical contents (files, computers, servers, equipment, research, and data) been located on levels of the facility above the flood elevations?  Suggestions: since the facility may require continued use even during flood, the potential for flooding should be recognized and steps taken to minimize loss of expensive equipment and irreplaceable data.	Choose one from the following options Type1, if located above flood elevation (critical contents -files, computers, servers, equipment, research, and data) Type0, if not located above flood elevation (critical contents -files, computers, servers, equipment, research, and data)	0	
	<b>STRUCTURAL ISSUES</b>			
S1 If siting in a floodplain is unavoidable, new facilities are to be designed to account for all loads and load combinations, including flood loads	Do the construction type and the foundation type have the required load bearing capacity against flood water?	If applicable, then carryout a visual inspection. If you think that a specialist's intervention is needed for assessment then mention it in the column "REFERENCES/REMARKS" If not applicable--> NA Type 1, if the facilities have the required load bearing capacity against flood water? Type 0, if the facilities do not have the required load bearing capacity against flood water?	0	

EXPLANATIONS/ SKETCHES	KEY QUESTIONS ON FLOOD-SAFETY OF EXISTING SCHOOL	GUIDANCE NOTES + POSSIBLE ANSWERS TO KEY QUESTIONS	Answer As per Guidance	REFERENCES/REMARKS
<p>S2</p> <p>Waves can exert considerable dynamic forces on buildings and contribute to erosion and scour.</p>	<p>Is the site prone to wind driven waves, which can take place in the coastal areas, riverine areas and site next to lakes? Waves can exert considerable dynamic forces on buildings and contribute to erosion and scour.</p>	<p>If applicable, then carryout an inspection &amp; consult historical data. If you think that a specialist's intervention is needed for assessment then mention it in the column "REFERENCES/REMARKS"</p>		
		<p>If not wave prone--&gt; NA</p>		
		<p>Type 1, If in wave prone areas, and the issue is adressed</p>		
		<p>Type 0, If in wave prone areas, and the issue not adressed</p>	0	
<p>S3</p> <p>If applicable, one can provide flood openings to automatically allow for inflow and outflow of floodwaters to minimize differential hydrostatic pressure</p>	<p>Does the school have enclosures below the flood elevation, meant for limited storage</p>	<p>Choose one from the following options</p>		
		<p>If not applicable --&gt; "NA"</p>		
		<p>Type 1, if school has enclosures below the flood elevation and is provided with flood openings to automatically allow for inflow and outflow of floodwaters to minimize differential hydrostatic pressure</p>		
		<p>Type 0, if school has enclosures below the flood elevation and is without flood openings to minimize differential hydrostatic pressure</p>	0	
<p>S4</p> <p>Refer to historical data on flooding to ascertain whether the expected water level is considerably higher than the bottom of the basement</p>	<p>If the ground water table is high and there is a basement, have you considered water load on retaining wall?</p>	<p>If applicable, then carryout an inspection. If you think that a specialist's intervention is needed for assessment then mention in column "REFERENCES/REMARKS"</p>		
		<p>Type "NA", if not applicable</p>		
		<p>Type 1, If water table is high &amp; you have designed retaining wall accordingly</p>		
		<p>Type 0, If water table is high &amp; you have not designed retaining wall accordingly</p>	0	
<p>S5</p> <p>Provide adeqaute depth of foundation and other local specific measures to protect the plinth and the foundation</p>	<p>If the building is in a place where flood water returns with speed to the nearby canal/river or sea causing scouring</p>	<p>Is the plinth adequately protected and the foundation has adequate depth?</p>		
		<p>If not applicable --&gt; "NA"</p>		
		<p>Type 1, if the issue of scouring effect has been adressed adequately</p>		
		<p>Type 0, if the issue of scouring has not been adressed</p>	0	

EXPLANATIONS/ SKETCHES	KEY QUESTIONS ON FLOOD-SAFETY OF EXISTING SCHOOL	GUIDANCE NOTES + POSSIBLE ANSWERS TO KEY QUESTIONS	Answer As per Guidance	REFERENCES/REMARKS
	<b>NON STRUCTURAL ISSUES</b>			
<p>NS1 Critical facilities in schools that depend on fresh water should be aware of the level of vulnerability of the local water supply system, and the system's plans for recovery of service in the event of a flood.</p>	<p>Is the potable water supply for the facility protected from flooding? If served by a well, is the wellhead protected? Can it be accessed during flood?</p>	Choose one of the following options		
		If not applicable --> "NA"		
		Type 1, If applicable, & the potable water source is protected during flooding		
		Type 0, If applicable, & the potable water source is not protected during flooding	0	
<p>NS2 Unprotected waste water service could casue a major disaster during and after flood with a long lasting detrimental effect on public life</p>	<p>Is the wastewater service for the building protected from flooding? Are any manholes below the Design Flood Elevation?</p>	Is infiltration of floodwaters into sewer lines a problem? If the site is served by an onsite system that is located in a flood-prone area, have backflow valves been installed?		
		Type NA, If not applicable		
		Type 1, if the wastewater service is protected from flooding		
		Type 0, if the wastewater service is not protected from flooding	0	
<p>NS3 Make sure that the tank openings and vents are elevated above the recorded elevation or the Design Flood Elevation</p>	<p>Are there any above ground or underground tanks on the site in flood hazard areas? Are they installed and anchored to resist flotation during the design flood? Is the tank openings and vents are elevated above the recorded elevation or the Design Flood Elevation?</p>	Choose one from the following options		
		Type NA, If not applicable		
		Type 1, if it is safe against flotation and vents elevated above recorded (historical) flood elevation		
		Type 0, if it is not safe against flotation and vents not elevated above recorded (historical) flood elevation	0	
<p>NS4 If not possible, locate them to higher floors or into elevated additions</p>	<p>Are plumbing fixtures and water meters, etc.) located above the recorded flood elevation?</p>	Choose one of the following options		
		Type NA, If not applicable		
		Type 1, of if you have located the plumbing fixtures and water meters, etc. above recorded (historical) flood elevation		1
		Type 0, if you have not located the plumbing fixtures and water meters, etc. above recorded (historical) flood elevation		



EXPLANATIONS/ SKETCHES	KEY QUESTIONS ON FLOOD-SAFETY OF EXISTING SCHOOL	GUIDANCE NOTES + POSSIBLE ANSWERS TO KEY QUESTIONS	Answer As per Guidance	REFERENCES/REMARKS
<p>NS5 Utility equipment that is critical for functionality should be relocated to higher floors or into elevated additions.</p>	<p>Is the early warning system located above the recorded (historical) flood elevation</p>	<p>Choose one of the following options (if this facility does not exist, mention this in column "REFERENCES/REMARKS")</p>		
		<p>Type NA, if this facility does not exist</p>		
		<p>Type 1, if early warning systems are safely located</p>		
		<p>Type 0, if early warning systems are not safely located</p>	0	
<p>NS6 Adequate factor of safety should be adopted while locating the communication/IT systems</p>	<p>Are the communication/IT systems located above the recorded (historical) flood elevation</p>	<p>Choose one of the following options (if this facility does not exist, mention this in column "REFERENCES/REMARKS")</p>		
		<p>Type NA, if this facility does not exist</p>		
		<p>Type 1, if IT/communication systems are safely located above the recorded (historical) flood elevation</p>		

## ANNEXURE IV: FIRE SAFETY EVALUATION: FOR EASE OF FILLING ANSWERS TO KEY QUESTIONS, ONLY THE COLUMN A,B,C,D & J HAVE BEEN SHOWN HERE

R E A D   T H I S   B E F O R E   A N S W E R I N G   T H E   K E Y   Q U E S T I O N S				
	User will read the following key questions in this column	Against each Key Question, the User will choose the appropriate answer from the given options shown in this column	<b>User's Input 1</b>	<b>User's input 2:</b> Follow the instructions in column C and type in the necessary information in this column
A	B	C	D	J
EXPLANATIONS/ SKETCHES	KEY QUESTIONS ON FIRE-SAFETY OF EXISTING SCHOOL	GUIDANCE NOTES + POSSIBLE ANSWERS TO KEY QUESTIONS	Answer As per Guidance	REFERENCES/REMARKS
	<b>PLANNING</b>			
<p style="text-align: center;">P1</p>  <p style="text-align: center;">Site plan showing access roads</p>	<p>An important aspect of safety of a building is the type of access road and safe entry for the school</p>	<p>Depending upon the type of access road to your site choose one from the following options;</p> <p>Type 1, if two or more roads from mainstreet to building wide enough to allow one fire engine to reach, reverse and return to the mainroad</p> <p>Type 2, if there is one access road of the above type</p> <p>Type 3, if access road is for cars and not fire engine</p> <p>Type 4, If the access road is suitable for motorbike only and not for cars</p> <p>Type 5, if it is for pedestrian access only</p>	<p>5</p>	
<p style="text-align: center;">P2</p> <p>Apart from site visit, the consultant should enquire about external fire hazards from local people and fire department's local office</p>	<p>With reference to the exterior of the school building, rate the building's exposure to external fires.</p>	<p>There could be various sources such as electrical substation, combustible materials store, etc. The consultant should visit the site to assess such potential fire hazards</p> <p>Type 1, if very high (school's exposure to external fire)</p> <p>Type 2, if medium (school's exposure to external fire)</p> <p>Type 3, if low (school's exposure to external fire)</p> <p>Type 4, no exposure at all (school's exposure to external fire)</p>	<p>4</p>	

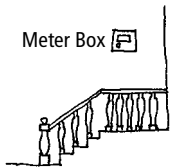
EXPLANATIONS/ SKETCHES	KEY QUESTIONS ON FIRE-SAFETY OF EXISTING SCHOOL	GUIDANCE NOTES + POSSIBLE ANSWERS TO KEY QUESTIONS	Answer As per Guidance	REFERENCES/REMARKS
<p>P3</p>  <p>Site plan showing open space</p>	Whether open space is available in the school for students to get assembled during fire?	In the column "REFERENCES/REMARKS, write the approximate length and width of such open space and the number of people who will need it →Choose one from the following options		
		Type 1, if there is adequate open space for gathering		
		Type 2, if there is open space, but not adequate for gathering		
		Type 3, if there is no open space for available for gathering	3	
<b>ARCHITECTURAL ISSUES</b>				
<p>A1</p> <p>For two storey buildings the openings have to be on the corridor side</p>	Do the existing classrooms have two exit routes (even windows can be widened to use as escape routes) in each classroom	Choose one from the following options		
		Type 1, if there are two escape routes in each classroom		
		Type 0, if only one escape route exists in each classroom	0	
<p>A2</p> <p>If yes, then relocate it</p>	Is the main meter box located in the staircase block?	Mention in column "REFERENCES/REMARKS", if there is no electricity. Choose one from the following options		
		Type NA if there is no electricity		
		Type 1, if the main meter box located in the staircase block		
		Type 0, if the main meter box located in safe place	0	
<p>A3</p>  <p>If yes, then consider relocating it</p>	Is the main switch located in the main entrance lobby/ passage/ corridor?	Mention in column "REFERENCES/REMARKS", if there is no electricity. Choose one from the following options		
		Type NA if there is no electricity		
		Type 1, if main switch is in the entrance lobby		
		Type 0, if main switch is located in safe location	0	
<p>A4</p> <p>Try to relocate possible sources of fire, e.g., kitchen, meter box, main switch, etc. from the staircase</p>	Is the the existing staircase adequately protected for safe evacuation during fire?	Choose one from the following options		
		Type "NA" if there is no staircase		
		Type 1, if the existing staircase is adequately protected for safe evacuation during fire		
		Type 0, if the existing staircase is not protected for safe evacuation during fire	0	

EXPLANATIONS/ SKETCHES	KEY QUESTIONS ON FIRE-SAFETY OF EXISTING SCHOOL	GUIDANCE NOTES + POSSIBLE ANSWERS TO KEY QUESTIONS	Answer As per Guidance	REFERENCES/REMARKS
<p>A5</p> <p>If it does not exist, build an external staircase, if possible. It should be at maximum distance from the main staircase</p>	<p>In case of a multistorey, is there a fire escape staircase? Use signnages</p>	Suggestion: keep the fire escape stairs at maximum distance from each other		
		Type NA, if not applicable		
		Type 1, if there is a fire escape staircase at maximum distance from main stair		
		Type 0, if there is no fire escape stair	0	
<p>A6</p> <p>In case it is not possible to provide a fire fighting water tank and there is no fire hydrant nearby, look for alternative sources such as a local perennial pond</p>	<p>Is there a fire fighting water tank of adequate size or if there is a local source for fire fighting</p>	<p>Choose one from the following options</p> <p>Type 1, if there is a fire fighting water tank of adequate size or if there is a local source</p>		
	<p>Use signnages</p>	<p>Type 0, if there is no fire fighting water tank of adequate size nor a local source</p>	0	
<p>A7</p> <p>Design a sprinkler system for the existing building, without dming the existing structural members</p>	<p>In case of a large school, has it been planned for sprinklers for the building?</p>	<p>Choose one from the following options</p>		
		Type NA if not applicable		
		Type 1, if sprinklers have been planned for		
		Type 0, if sprinklers have not been planned for	0	
<p>A8</p> <p>If not, then modify the existing doors and ensure that the doors opening to the corridors are safe for children’s movement</p>	<p>Do the doors open outside?</p>	<p>Choose one from the following options</p>		
		Type 1, if doors open outside		
		Type 0, if the doors open inside	0	
<p>A9</p> <p>If it is close to the classrooms, try relocating it. Else make adequate fire fighting arrangements</p>	<p>Is the kitchen located at a safe distance from classrooms</p>	<p>If there is no kitchen mention this in the column “REFERENCES/REMARKS” -Choose one from the following options</p>		
		Type “NA” if there is no kitchen		
		Type 1, if kitchen is at a safe distance from classrooms		
		Type 0, if kitchen is not at a safe distance from classrooms	0	
<p>A10</p> <p>If not fire safe, apply appropriate treatment. Retrofit the existing fixing in case there are distresses</p>	<p>Is the ceiling material safe from fire?</p>	<p>Choose one from the following options</p>		
		Type “NA” if not applicable		
		Type 1, if ceiling materials used is not fire prone		
		Type 0, if ceiling materials used is fire prone	0	

EXPLANATIONS/ SKETCHES	KEY QUESTIONS ON FIRE-SAFETY OF EXISTING SCHOOL	GUIDANCE NOTES + POSSIBLE ANSWERS TO KEY QUESTIONS	Answer As per Guidance	REFERENCES/REMARKS
	<b>STRUCTURAL ISSUES</b>			
S1 Take special care for steel and timber members	Did the designer use less fire prone materials? Or else has the structural members been insulated to protect it in the event of fire?	Did the designer provide insulation as per code for RCC, steel, timber, stone structure- mention the code name/source in column "REFERENCES/ REMARKS"		
		Type 1, if structural members insulated adequately or less fire prone building materials are used		
		Type 0, if structural members not insulated and/or fire prone building materials are used	0	
	<b>NON STRUCTURAL</b>			
NS1 Use only national standard's approved products and also based on past experience	Is the quality of wiring used of adequate quality	Choose one from the following options, mention in column "REFERENCES/REMARKS", if there is no electricity		
		Type "NA" if no electricity		
		Type 1, if used wires are of national standards' approved quality		
		Type 0, if used wires are not of national standards' approved quality	0	
NS2 Use earthing pit of 1mX1mX2.5m deep installed with Galvanized cast Iron Plate. Alternatively, one may use specifications as per the local practice	Has earthing been done in the wiring system?	Choose one from the following options		
		Type "NA" if not applicable		
		Type 1, if earthing has been done		
		Type 0, if earthing has not been done	0	
NS3 Your building may not need it, if there are adjacent buildings provided with lightning bars	Has Lightning arester been fixed in the building	Choose one from the following options		
		Type "NA" if not applicable		
		Type 1, if Lightning arrester been fixed or there is a nearby tall building with lightning bar or a tower		
		Type 0, if Lightning arrester not been fixed	0	
NS4 If yes, then try relocating it	Is the emergency batteries such as Inverter located near the entrance to the building?	Choose one from the following options		
		Type NA if not applicable		
		Type 1, if emergency batteries such as Inverter located safely in the building		
		Type 0, if emergency batteries such as Inverter located in the entrance lobby of the building	0	

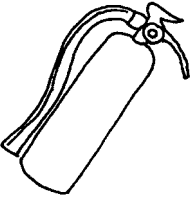
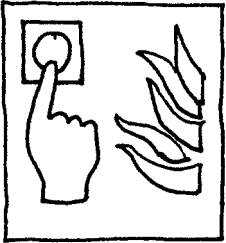
EXPLANATIONS/ SKETCHES	KEY QUESTIONS ON FIRE-SAFETY OF EXISTING SCHOOL	GUIDANCE NOTES + POSSIBLE ANSWERS TO KEY QUESTIONS	Answer As per Guidance	REFERENCES/REMARKS
<p>NS5</p>  <p>Strap them adequately with the walls</p>	<p>Is there a fire fighting arrangements/ extinguisher kept at convenient place for fire fighting, especially in the Chemistry lab</p>	<p>Choose one from the following options</p> <p>Type 1, if a fire extinguisher kept at convenient place for fire fighting, especially in Chemistry lab</p> <p>Type 0, if there is not fire extinguisher in the building, especially in Chemistry lab</p>	<p>0</p>	
<p>NS6</p> 	<p>Is there a provision for fire alarm?</p>	<p>Choose one from the following options</p> <p>Type 1, if there is provision for fire alarm</p> <p>Type 0, if there is no provision for fire alarm</p>	<p>0</p>	

## ANNEXURE V: SUPPLEMENT TO TOOLKIT II: SCHOOL CONDITION ASSESSMENT: SUPPORT TO EMIS<sup>2</sup>

Educational database is updated every year by the school teachers. At present it is maintenance centred and subjective. This Supplement to the Toolkit Part II intends to act as a support to the existing EMIS forms. It is envisaged that this supplement will enhance the ability of the school teachers and the school committees to acquire more objective type maintenance data than at present. This supplement also aims to acquire some amount of retrofitting related data on non-structural risk. While the Toolkit II will provide a comprehensive picture on retrofitting needs, this supplement will provide data on the actual physical condition of the building and facilities. These two combined will enable the top level management to assess the retrofitting cum maintenance needs, prioritize and decide whether detailed investigation is required for a particular building. The following is a suggested addition to the existing EMIS data collection form.

Special Note: The EMIS department to treat the tables in this section as additions to the existing database

### PREPARE A SITE PLAN: PROPORTIONATE SKETCH

The survey should be done by school teachers, SMC<sup>3</sup>, local mason and, if possible, a JE. The first job of the team will be to carry out the following.

- Draw the campus boundary first
- Draw the open spaces and write on the paper such as play field, water body etc.
- Draw the buildings and mark them as B1, B2 etc.
- Mark the rooms of each building as B1/R1,R2,.....,

B2/R1.R2,..... etc.

- Draw the toilets T1, T2, DW facilities DW1, DW2 and the disposal system,
- Write the evacuation road width
- Draw the big trees inside and near the compound
- For each building use the format in the following pages and carryout the defect identification and recording.
- Mark the highest observed flood water level on the wall of one of the existing buildings, if applicable

### AN ILLUSTRATED EXAMPLE OF HOW TO PREPARE A SITE PLAN

Figure V.1: Site Plan

Fill up the following asset register

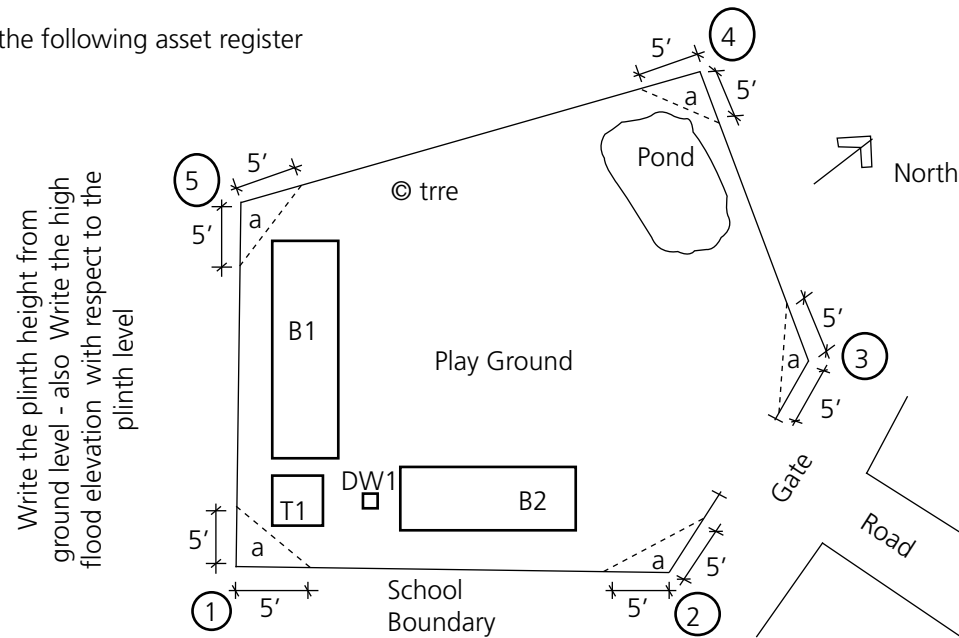

- At corner 1, 2, 3, 4 and 5 mark at 5' as shown in the above figure and the measure the distance "a1, a2, a3, a4 ....." at all five corners.
- Measure 1-2, 2-3, 3-4, 4-5 and 5-1 and write on the above drawing
- First measure the plinth height of B1 or B2 and mark on the drawing as shown. Take a level pipe and mark the high flood level of the plinth level. For example, if the high flood level is 2' below the plinth, then write HFL (-2'). In case the high flood level is 3' above the plinth level then write HFL (+3')
- Write about existing use pattern of the adjacent plots

<sup>2</sup> Education Management Information System

<sup>3</sup> School Management Committee

Table V.1: Asset Register: Record of the school buildings and their physical conditions: Use separate pages if necessary

Facilities mark as/ site plan	No of storey	Function and no of rooms	Who constructed	Age in years	Construction Cost	maintenance history	Type of construction methods adopted in the building				Impression on maint. need **
							Foundation	Wall	Roof	Floor finish	
e.g. B1		e.g. class/8 rooms					e.g. wall footing in brick + cement mortar	e.g., brick wall in cement mortar	RCC	Cement floor	
e.g. B2		e.g. office/2 rooms									

\*\* Type 1 if building/ facility is in good condition - no need for maintenance, Type 2 if building/ facility is in OK condition, need for routine maintenance, Type 3 if building/ facility needs minor repair, Type 4 if building/ facility needs major repairs, Type 5 if building/ facility is unsafe – to be replaced

## THE INSPECTION PROCESS

Tools Required For Inspection: Carry a small hammer, 20 ft long level pipe, a plumb, a 30 m tape, papers, one graph paper A3 size, one ladder, 1mm, 2mm, 3mm, 4mm wires, coloured chalks.

Inspection: Use the following checklists to determine which items require attention and then determine what action should be taken. The areas of the school buildings to be inspected are the following:

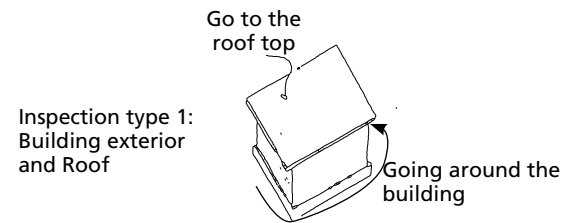

Inspection type 1: Building exterior and Roof

- Inspection type 2: Building interior
- Plumbing
  - Electrical
  - Furniture and equipment

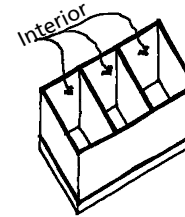

## HOW TO CARRY OUT THE INSPECTION

The inspection will start with primarily visual observations of the inside and outside of the school, simply by walking around the interior and the exterior. Use the hammer and level pipe wherever asked for in the following format.

## GENERAL NOTES FOR INSPECTION TEAM MEMBERS

Hairline cracks in concrete columns, beams, structural walls, and floors are usually of less concern – these may be deferred. However, if the cracks are of following types, survey team should consult an engineer.

- if the cracks are more than 4mm wide;
- if they appear to be getting larger,
- if water is seeping through the cracks.

## INSPECTION TYPE 1: THE BUILDING EXTERIOR

A visual inspection of the exterior of the school building should be done by looking for the following in Table 2- presence of these indicate that maintenance action is needed.

In exterior brick, concrete block, or any masonry walls, the basic concerns are cracking and water intrusion. Water can affect masonry in different ways. Over a period of time, water can erode the mortar, causing the original mortar mix to disintegrate. If there are cracks, there are more openings for water to enter. Cracks must be filled to avoid water getting inside and causing further deterioration of the surface.

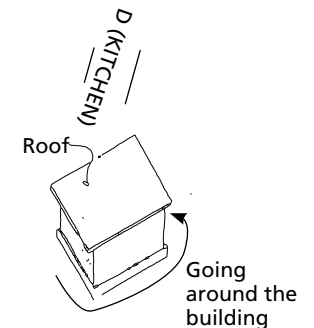
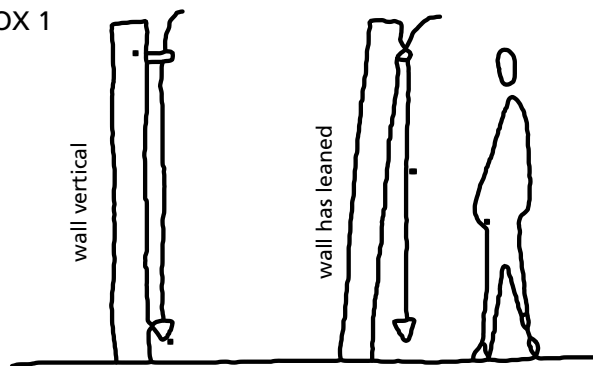



Table V.2: Do not fill up if the defect does not exist. Make a special mention of those cracks that have appeared since the last observation

Building component	Do the following defects exist? Record if other types, not mentioned here, exist on the exterior.	Where are the unsatisfactory components located as/ Table V.1? write the quantities for each defect	Priority of importance– Urgent/ Important/ Medium/ low
Walls Box 2	Is there a vertical crack on the wall- wider than 1mm? if yes measure the width & length- does water seep through?		
Box 2	Is there a horizontal crack in the wall – wider than 1mm? is it stair stepped? - does water seep through? measure length		
Box 2	Is there a diagonal crack in the wall – wider than 1 mm? - does water seep through? measure length		
Box 1	Is any wall out of plumb? Bend/twist/ deformed		
	Is there a crack where two walls meet? measure length		
	Is there damp patch on wall? measure length		
	Is there presence of any damaged plaster? Tap the wall plaster with a small hammer- if dull sound is emitted mark the damaged portion and measure the area		
Box 3	Is there a crack at wall-roof junction? measure length		
	Is there a whitish film deposited on the wall, this is called efflorescence and is the result of dried mineral salts. Measure area		

BOX 1



BOX 2

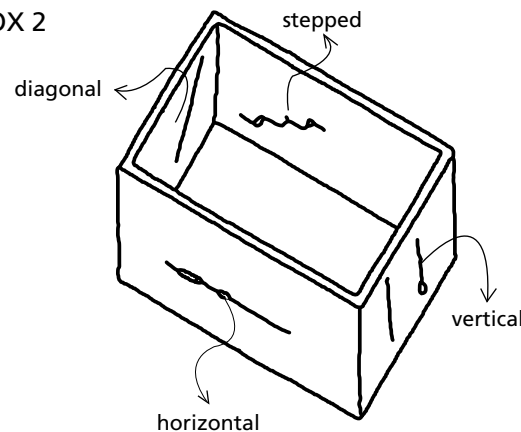

BOX 3

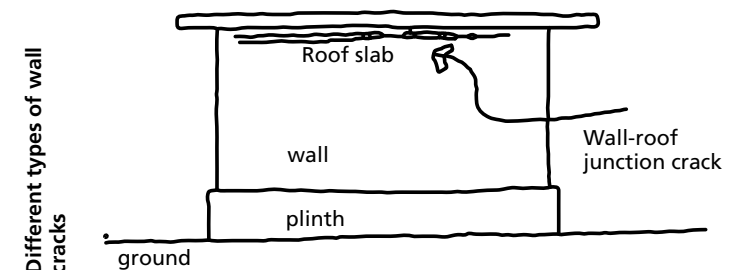

Different types of wall cracks

Different components of the building	Do the following defects exist? Record if other types, not mentioned here, exist on the exterior.	Where are the unsatisfactory components located as/ Table V.1? write the quantities for each defect	Priority of importance– Urgent/ Important/ Medium/ low
Corridor railings and posts			
Paints	Peeling of paint? Is there stain on wall? Room looking shabby? Measure area		
Others	Check the same as above for door, window and grills, Measure area algae or mold that is now growing on walls, bushes and shrubs that now touch the school building's exterior. Trees growing from, wall, roof, etc.		
	Is there a plinth protection? is the existing plinth protection damaged? Measure area		
Differential settlements Box 5	Carryout the investigation as in the footnote**. If differential settlement > 2", mark the location in plan. measure length		

\*\* Select any one corner of the room and mark with a pencil at a height of 3 feet from the floor level. With water level pipe mark at all four corners of the building matching with the first mark. Measure the heights of these marks from the ground. Check whether there is a difference of greater than 2" at any one corner.

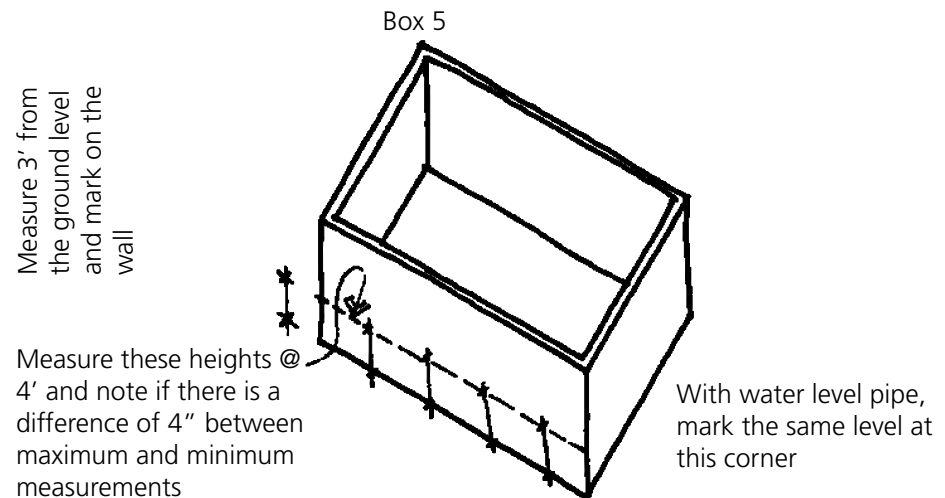
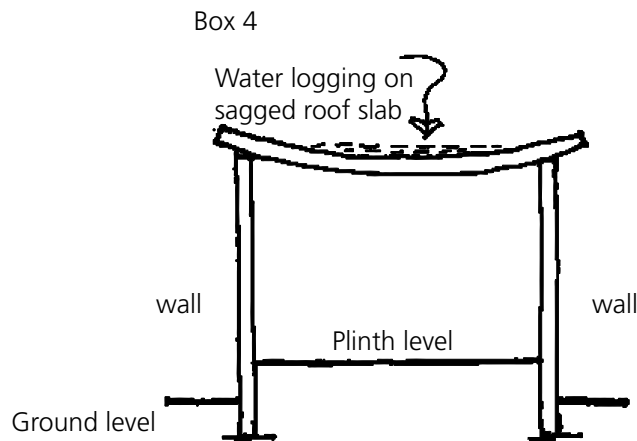

Table V.3 ROOF STRUCTURE : Go to the roof top for inspection

	Do the following defects exist? Record if other types, not mentioned here, exist on the exterior.	Where are the unsatisfactory components located as/ Table V.1? write the quantities for each defect	Priority of importance– Urgent/ Important/ Medium/ low
Roof	Does the roof top appear undulating? Deflected?		
Box 4	Is there water logging on the roof? Is it at places – mark with a chalk and measure the area		
	Is the rainwater down pipe chocked? Horizontal spouts blocked?		
	Can you see damaged waterproofing on the roof top? If you cannot see that then tap the roof surface with a hammer – if dull sound is emitted then mark the places where it exists and measure the area		

### INSPECTION TYPE 2: BUILDING INTERIOR INCLUDING CORRIDORS

Look for cracks that are visible either on one side or both. Pay special attention to them. The horizontal cracks need special attention. A vertical crack, or one that is stair shaped (see box 2), could be due to differential settlement. If there is crack where the walls join other elements such as roof slab to wall, wall-beam- wall-column, create a groove in the plaster to hide the crack.

- Inspection type 2:  
Building interior
- Plumbing
  - Electrical
  - Furniture and equipment

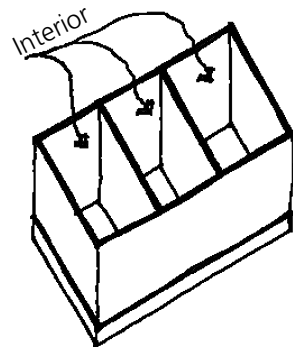

Table V.4 Do this inspection Room by room of each building, e.g., B1, B2, ....

	Do the following defects exist? Record if other types, not mentioned here, exist on the exterior.	Where are the unsatisfactory components located as/ Table V.1? write the quantities for each defect	Priority of importance– Urgent/ Important/ Medium/ low
COLUMNS	If emits dull sound when struck lightly on surface with a hammer. Measure length		
Timber, steel, RCC	Vertical cracks width more than 1 mm- measure the length and width of crack. if water seeps through such cracks, measure length		
	If damaged corners exist, measure length		
Box 7	If out of plumb by >2", treat it as urgent		
Box 6	are there visible reinforcing rods? Has the rods bulged? measure length		
	If there is exposed rods but the column is not out of plumb or the rods are not bulged		
Any others			

#### Box 6

Reinforced cement concrete column- rods exposed and cover concrete eroded



If the rods of the column shown on the left has buckled as shown below, consult an engineer

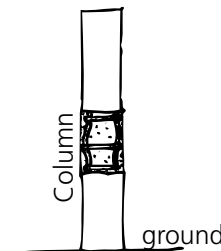

#### Box 7

If the rods of the column shown on the extreme left has leaned as shown below, consult an engineer

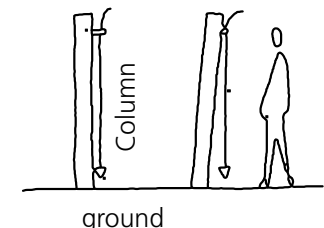

Table V.4 contd.. is Room by room

Do the following defects exist? Record if other types, not mentioned here, exist on the exterior.		Where are the unsatisfactory components located as/ Table V.1? write the quantities for each defect	Priority of importance– Urgent/ Important/ Medium/ low
Masonry Wall	Is there a vertical crack on the wall- wider than 1mm? if yes measure the width & length		
	Is there a horizontal crack in the wall – wider than 1mm? is it stair shaped? Is there water seepage thro' that?		
	Is there a diagonal crack in the wall – wider than 1 mm? Is there water seepage thro' that?		
	Is any wall out of plumb? Bend/twist/ deformed		
	damp patch areas? measure		
	Is there rising dampness in the wall? if yes then measure length		
Ground Floor	Undulating floor by more than 2"? measure area		
Box 8	Are there floor cracks wider then 1mm? measure length		
Box 9	Walk along periphery of room & watch the floor and wall junction – do you see a crack? Is it continuous or discontinuous? measure length		
	Is there floor dampness? measure areas		
	Is the floor finish damaged? If you cannot see that then tap the floor surface with a hammer – if dull sound is emitted then mark the places where it exists and measure the area		

Important note: for wall defects refer to the section on exterior wall

Table V.4 contd.. is Room by room

Box 8

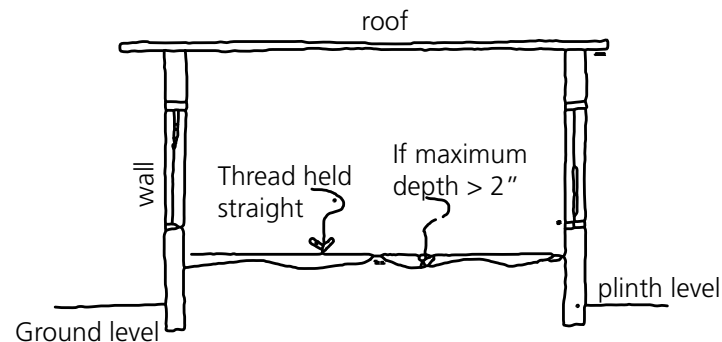

Drawing shows the floor of a room- note if you find this defect

- hold a thread as shown by touching the highest point of the floor and check if the maximum depth of any other portion of the floor is > 2"

Box 9

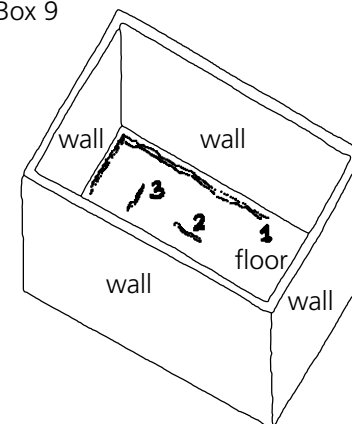

Drawing shows the floor of a room- note if you find this defect

- Crack type 1 at wall-floor junction
- Crack type 2 and/or 3 on floor

Do the following defects exist? Record if other types, not mentioned here, exist on the exterior.		Where are the unsatisfactory components located as/ Table V.1? write the quantities for each defect	Priority of importance– Urgent/ Important/ Medium/ low
<b>BEAMS</b>	Emits dull sound when struck lightly on surface with a hammer		
RCC, timber, steel	Cracks- across at mid span or diagonal cracks at ends		
	Damaged corner		
	Has the beam Deflected ?		
	Cover concrete crack of fallen off		
Ceiling	Can you see that the roof has sagged?		
	Is there a prominent damp patch in the ceiling – is water seeping through crack- measure area		
Box 10	Is there a visible crack in the ceiling at mid span and near supports		
	Is concrete falling off in patches? Can you see the rods- measure area		

Box 10

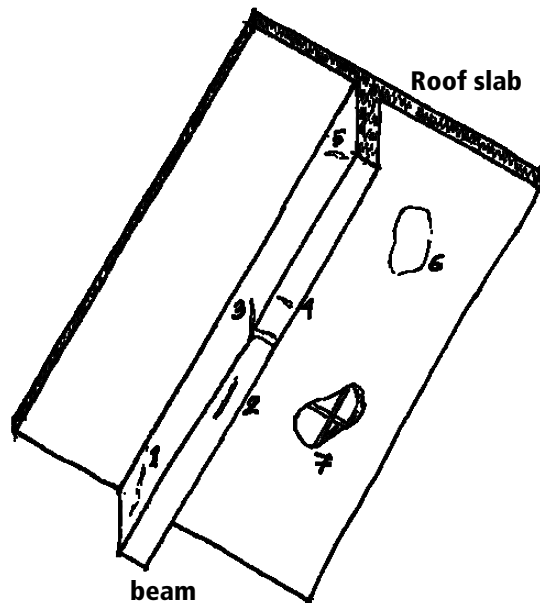

**Drawing shows the ceiling and beam- note if you find**

- Crack type 1 at beam ends
- Crack type 2 and/or 4 on beam bottom
- Crack type 3 at mid span
- Exposed rods as in 7
- Cover concrete fallen off

Table V.4 contd.. is Room by room

	Do the following defects exist? Record if other types, not mentioned here, exist on the exterior.	Where are the unsatisfactory components located as/ Table V.1? write the quantities for each defect	Priority of importance– Urgent/ Important/ Medium/ low
Lintel over window & door opening	has the lintel deflected? Do you see the rods?		
	Look at the bottom of the lintel - is there a crack across the width and at centre?		
	Is there a crack at wall support?		
Interior windows	Do windows should open and close easily? if defect exists mention number of such cases		
Window shutter	Are there damaged Window shutters? if yes measure area		
Plastering	With a small hammer, tap the wall, ceiling, beam, column etc. that has plaster - if dull sound is emitted mark the area- re-plastering is necessary		
Paints	Peeling of paint? Is there stain on wall? Room looking shabby? measure area		
	Check the same as above for door, window and grills		
Other			
Remarks			

How do you check deflection? With water level pipe mark two ends of the lintel and hold a thread tightly along the marks. Deflection will be visible.

## FURNITURE, WATER, SANITATION, ELECTRICAL

Table V.5: Condition assessment of furniture/equipment

Furniture/ Equipment	Age of facility in years	Total Nos	Repair needs (nos)	Replacement needs (nos)	Supply of new (nos)	Priority- urgent, important, less important
Furniture/ fixture						
Desks						
Chairs						
Boards						
Case wardrobes						
Tables						
Audio visual aids						
Computers and attachments						
Typewriter						
Acids in Lab						
Photocopier						
Almirah						
Refrigerator /freezer						
Lab equipment						
Musical instruments						
Sport equipment						
Office supplies						

Book shelves in classroom						
Television Sets						
Water Supply + Sanitation						
Water tanks						
Sinks						
Faucets						
Tanks						
Septic Tank						
Electrical						
Control panel box						
Switches and sockets						
Internal lighting (lamps and bulbs)						
Exterior lighting						
Fans						

Table V.6: Retrofitting Needs of Furniture And Equipment

Furniture/ Equipment	Age (years)	If anchored, how many years back	Location--> GF(1) /FF(2) /SF(3) /TF(4) />TF(5)	Anchorage → Type 1, If yes, 0, if no			Material of anchorage, type 1, where applicable			Present condition of the anchor  Good as new (1), OK(2), min. maint. (3), medium maint (4), major maint (4),replacement (5)	Mention the level of equipment/furniture  Type 1, if PL > 300mm from HFE, Type 2, if lower than HFE, Type 3, of < 300mm below HFE	Type 1 if protected from high wind, type 0 for no
				At base	On top	at sides	Metal	wood	other			
Desks												
Chairs												
Boards												
Case wardrobes												
Tables												
Audio visual aids												
Computers and attachments												
Typewriter												
Acids in Lab												
Photocopier												
Almirah												
Refrigerator /freezer												
Lab equipment												

Musical instruments												
Sport equipment												
Office supplies												
Book shelves in classroom												

\*\* this should be supplemented with photos

### SUMMARY OF DEFECTS:

School administration should gather the statements below in order to come up with a consolidated list of defects and prepare a maintenance plan and budget. In case maintenance process is simple (the black ones) and within the capabilities of the school teachers a time frame and cost can be estimated. If the maintenance needs a lot of money (decide the ceiling) and/or the repair items are beyond their capabilities, the departmental engineers will inspect the school site and accordingly prepare a budget.

The acquired data should be tabulated by the school teacher and checked by the local level engineer. The checked data will be sent to the district for logging it into the computer against the EMIS number of the schools, which will be sent to the DoE

Table V.7: Summary of defects

SCHOOL BUILDING MAINTENANCE PROGRAMME							Date of inspection		
Name of person who filled out the form:									
List of problems according to priority									
Sl no	Defect type	Defect description	Age of the facility	Location of the defect	Quantity-volume/ Area/ length	Unit cost	Estimated cost	Time frame	priority
1									
2									
3									
4									
5									
6									
7									
8									
9									
10									



# ANNEXURE: VI FIELD TEST: MULTI-HAZARD RETRO-MAINTENANCE NEED ASSESSMENT SCHOOL AT LALITPUR, NEPAL

Figure VI.1: Field test: Adarsha Kanya Niketan School, Lalitpur, Nepal

RETROFITTING ASSESSMENT USING TOOLKIT II: B3+CAMPUS

CONDITION ASSESSMENT USING SUPPLEMENT: B3

Field Testing Done on the 26<sup>th</sup> April 2012

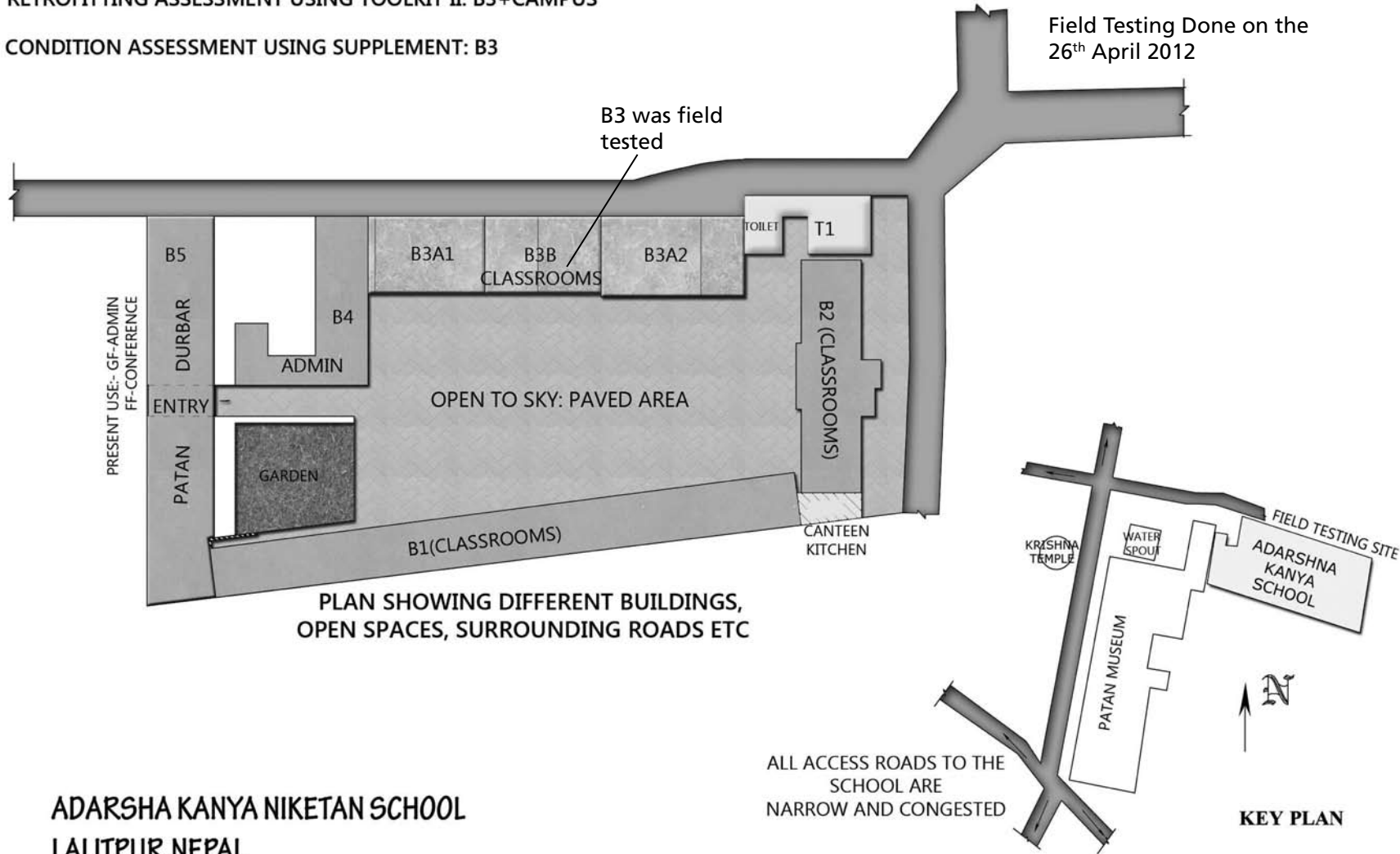

PLAN SHOWING DIFFERENT BUILDINGS, OPEN SPACES, SURROUNDING ROADS ETC

ADARSHA KANYA NIKETAN SCHOOL  
LALITPUR, NEPAL

Figure VI.2: Condition Assessment of Building B3 (Classro



SOUTH ELEVATION

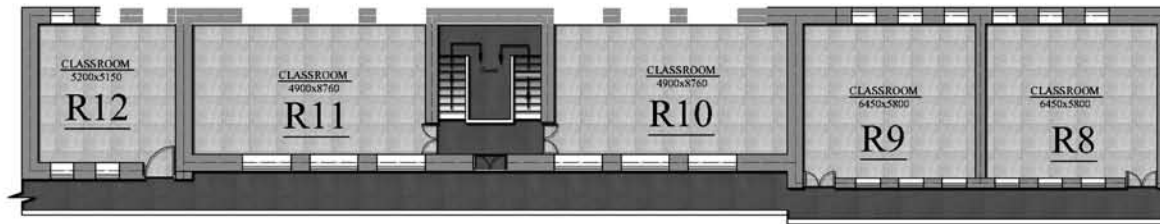

FIRST FLOOR

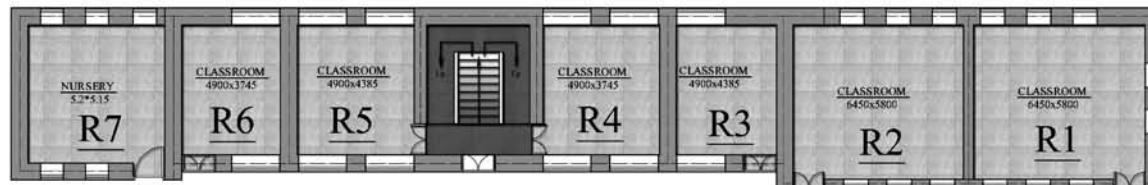

GROUND FLOOR

**ANANDA KANYA NIKETAN SCHOOL  
LALITPUR, NEPAL**

PLANS SHOWING ROOM NUMBERS

Figure VI.3 The process of field test and some defects in Building B3 (Classrooms)

### FIELD TESTING:- ADARSHA KANYA NIKETAN HIGHER SECONDARY SCHOOL, LALITPUR



THE PROCESS: FIELD TEST → THE SCHOOL TEACHERS, COMMUNITY, MASON, ETC



DEFECTS: A FEW EXAMPLES

Table VI .1: Asset Register

Facilities mark as/ site plan	No of storey	Function of facility & no of rooms	Who constructed	age facility	Construction cost (USD)	Maintenance history	Type of construction methods adopted in the building				Maintenance requirements of building **
							Foundation	Wall	Roof	Floor finish	
B1	1	Classroom; 10	Not known	35 yrs	Not known	Not known	Not known	Brick in cement mortar	Timber with CGI	Cement plaster	3
B2	3	Class+ lab 8	Not known	50 yrs	Not known	Not known	Not known	Brick in mud mortar	Reinforced Brick Concrete	Cement plaster	3
B3	2	Class; 12	Not known	36	Not known	Not known	Not known	Brick in surkhi	B3A1=B3A2=Timber+ CGI; B3B,Steel truss +CGI	Cement plaster	4
B4	2	Office+ library; 4	Not known	36	Not known	Not known	Not known	Brick in cement lime surkhi	Inter.Timber floor + timber truss & CGI	Cement plaster	3
B5	3	GF: office FF: community TF: hall	Bahadur shah	200	Not known	Not known	Not known	Brick in cement surkhi	Wooden floor with tile	Tile flooring	4 Heritage building special attention
T1	1	Toilet; 2	D.E.O	Not known	Not known	Not known	Wall footing	Brick in cement mortar	Timber with CGI	Cement plaster	2

\*\* Type 1 if building/ facility in good condition - no need for maintenance, Type 2 if building/ facility in OK condition, need for routine maintenance, Type 3 if the building/ facility needs minor repair, Type 4 if the building/ facility needs major repairs, Type 5 if the building/ facility is unsafe – to be replace

Table VI .2: Condition Assessment Furniture

Furniture/ Equipment	Total Nos	Repair needs (nos)	Replacement needs (nos)	Supply of new (nos)
Desks	162+138	45		
Chairs	28			
Boards (white)	26			
Tables	1+62+14=77			
Computers and attachments	24		16	
Acids in Lab (Hso4+HCL)	2+1=3			
Photocopier	1			
Almirah	14+19+4=37			
Photocopier	1			
Lab equipment	68			
Book shelves in classroom	1			
Funnel	15			
Cubical flask	12			
Microscope	2			
Kerosene burner	16			
Specimens	23			

Table VI.3: Retrofitting Needs of Furniture And Equipment

Furniture/ Equipment	Age (years)	If anchored, how many years back	Location--> GF(1) /FF(2) /SF(3) /TF(4) />TF(5)	Anchorage → Type 1, If yes, 0, if no			Material of anchorage, type 1, where applicable			Present condition of the anchor	Mention the level of equipment/furniture	Type 1 if protected from high wind, type 0 for no
				At base	On top	at sides	Metal	wood	other			
Desks	30-40	NA	1,2,3	0	0	0	NA	NA	NA		1	1
Chairs	30-40	NA	1,2,3	0	0	0	NA	NA	NA		1	1
Boards	4	4	1,2,3	1	1	1	1			2	1	1
Tables	25	NA	1,2,3	0	0	0	NA	NA	NA		1	1
Computers and attachments	7	Not anchored	2	0	0	0	NA	NA	NA		1	1
Acids in Lab	3	Not anchored	1	0	0	0	NA	NA	NA		1	1
Photocopier	5	Not anchored	2	0	0	0	NA	NA	NA		1	1
Almirah	23	Not anchored	1,2,3	0	0	0	NA	NA	NA		1	1
Lab equipment	14	Not anchored	1	0	0	0	NA	NA	NA		1	1

\*\* this should be supplemented with photos

Table VI .4: Summary of Defects: B3

SCHOOL BUILDING MAINTENANCE PROGRAMME	Date of inspection	26th April, 2012
Name of person who filled out the form: Purna Ganesh Ranjitkar, Binod Shrestha		

S. No	Defect type	Defect description	Age of facility	Location of the defect	Quantity-volume/ Area/ length	Unit cost	Estimated cost	Time frame	Priority- urgent, important, less important
2	Wall cracks	cracks diagonal	36 YEARS	B3/R7,R9,R10,R1	4m				Important
3	Cracks in the wall corner/ joints	corner cracks, no tie up between the main wall and cross wall		B3/R5	3m				Important
4	Damaged plaster	At several places in interior and exterior damaged plaster to be replaced		B3/R7,R9,R10,R1	15 sq m +15% of surface area				Important
5	Vertical cracks	vertical crack on the wall- wider than 1mm		B3/R2, B3/R4 B2/R5.	13 ft				Important
6	Floor cracks	About 1.5mm wide crack		B3A2/R8, B3B/R5.	10m				Important
7	Damaged floor finish	Majority of the floor to be redone		B3B/R4,R5; B3A2/R7 &8.	60 Sq m				Important
8	Horizontal cracks in timber joists	Though non structural , might reduce durability		B3B/R 4 &R5;	5 joists, 6m long each				Important
9	Is concrete falling off in small patches? Can you see the rods	Poor quality concrete, exposure to rains caused this distress		periphery of B3	10sqm				Urgent
10	Wall crack at lintel	One time crack		B3/R3	2m				Important

## RETROFITTING NEED ASSESSMENT (USING TOOLKIT II)

Compliance index 0 → No safety as per norm , 1 → 100% Safety as per norms

Figure VI.4: Showing Scores: Seismic, Fire and Multi-Hazard Safety

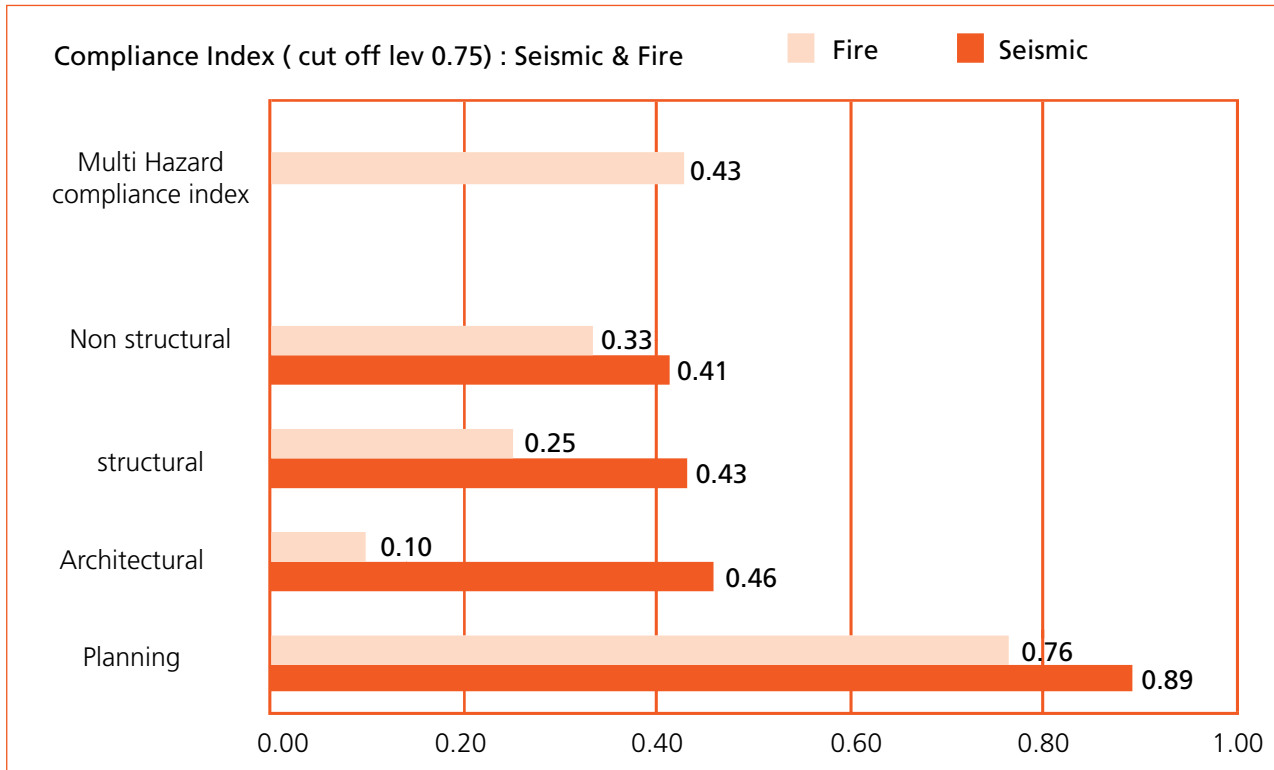

The weights shown on the right were put forward by the Expert Group Meeting Held at Kathmandu (25th -26th March 2012). However, in any other context, the country level experts may change these to suit the local conditions.

The following two Tables VI.5 & VI.6 show the retrofitting needs of building B3

Figure VI.5: Weights considered

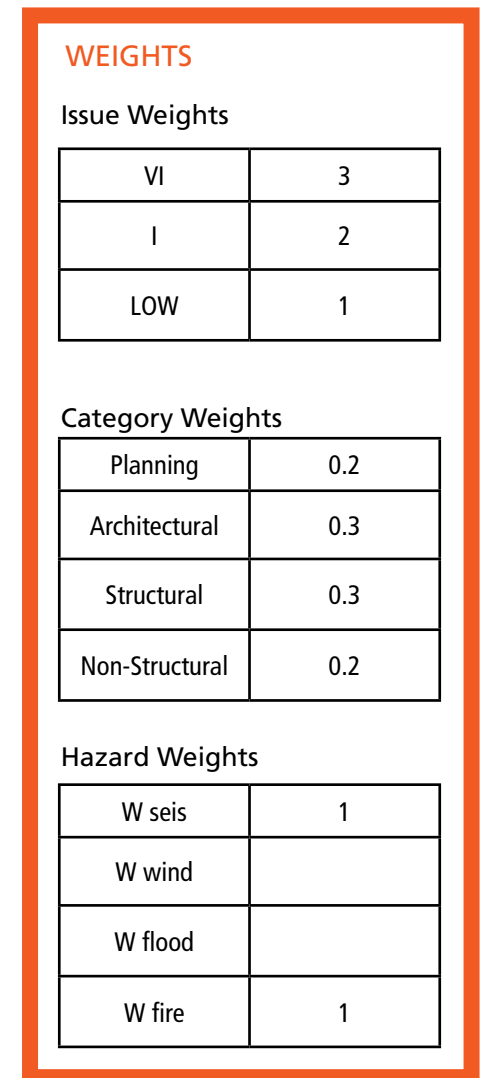

Table VI .5: Retrofitting actions to be taken to enhance SEISMIC SAFETY of School at Lalitpur, Nepal

ISSUE NO	ISSUES	SEISMIC COMPLIANCE	REFERENCES/ REMARKS
PLANNING			
P4	Type 0, If in-house backup sources of water has not been provided in the school	0.25	
P6	Type 2, if there is open space, but not adequate for gathering	0.5	700 students +teachers needing 350sqm (existing courtyard 814sqm (18mx44m)
ARCHITECTURAL ISSUES			
A3	Type 3, if the design is poor for evacuation of physically challenged people	0.1	A special study to be undertaken by the community to make arrangements in this respect.
A4	Type 4, there is no emergency exist in design	0.05	A special study to be undertaken by the community to improve this
STRUCTURAL ISSUES			
S1	Is the existing building safe according to the seismic micro zoning factors?		Specialists' intervention is needed
S5	If the school is a Masonry Structure, were vertical reinforcements & horizontal bands provided in walls according to code?		Inspection could not be done
S6	Was the reinforcement detailing done as per code to ensure ductility of the structure?		Inspection could not be done
S7	Type 0, If seismic load has not been considered in design	0.05	
NON STRUCTURAL ISSUES			
NS1	Type 0, if plumbing lines are not supported and braced	0.25	
NS2	Is overhead water tank or elevated water tank safely placed and anchored adequately		no fire projection facility
NS3	Type 0, if you have not provided flexible joints in lab and the lines clamped at suitable points	0.05	



Table VI .6: Retrofitting actions to be taken to enhance FIRE SAFETY of School at Lalitpur, Nepal

ISSUE NO	ISSUES	SEISMIC COMPLIANCE	REFERENCES/ REMARKS
	PLANNING		
P3	Type 2, if there is open space, but not adequate for gathering	0.5	
	ARCHITECTURAL		
A1	Type 0, if only one escape route exists in each classroom	0.05	
A6	Type 0, if there is no fire fighting water tank of adequate size nor a local source	0	
A8	Type 0, if the doors open inside	0.05	This could be changed with least investment
A9	Type 0, if kitchen is not at a safe distance from classrooms	0.05	Consider relocating the kitchen or else make adequate provision for fire fighting
	STRUCTURAL		
S1	Type 0, if structural members not insulated	0.25	
	NON-STRUCTURAL		
NS1	Type 0, if used wires are not of national standards' approved quality	0.25	
NS3	Type 0, if Lightning arrester not been fixed	0	
NS5	Type 0, if there is not fire extinguisher in the building, especially in Chemistry lab	0.25	
NS6	Type 0, if there is no provision for fire alarm	0.25	

## SUMMARY OF OBSERVATIONS

The approach roads to the school are highly congested and narrow. In a couple of places there were sharp bends. One has to be very careful even when driving a small car. Access for fire engine will be a problem even though there were two main access roads to the school. Very old buildings surround the school and many of them are heritage buildings and need retrofitting need assessment. Apart from that, in case of fire in these buildings, the approach road could become difficult for the fire engine to access.

The masonry pillars of the building B3 were highly vulnerable to seismic forces. There is an urgent need for reinforced skin around them to take lateral force safely. There were potential fire hazards due to old wiring system and presence of timber as primary spanning system in many classrooms. Apart from that lack of fire alarm and fire extinguisher, etc. were potential threats to the school. The school did not have water reservoir for fire righting.

The condition assessment revealed that there were no evidence of regular housekeeping and routine maintenance. The distresses were identified and recorded by the team consisting of a trainer and the teachers from a few schools. The participants agreed that an increased awareness and capacity building would have eliminated most of the defects. Because of long neglect on maintenance, the rooms in B3 were damaged. The teachers involved in the survey, realized that it is

## ENDING REMARKS

This is School Safety Toolkit Book 2: Retro-maintenance, Multi-Hazard Safety Compliance

It has provided the following four sets of data collection forms

1. Seismic Safety Evaluation
2. Wind Safety Evaluation
3. Flood Safety Evaluation
4. Fire Safety Evaluation
5. Condition assessment

The surveyors/users should read these forms before initiating the investigation for retrofitting. Only the relevant forms should be used for examining safety compliance

they who can keep up the school by close vigilance on the building and its facilities. The detailed list of distresses is in Table VI .4

The lab needed immediate retrofitting of its pipe lines. The roof top water tank was highly vulnerable and may fall down even with medium tremor.

The evacuation route of the school was very poor. However, it would not need much of money to find out an emergency exist to the side lanes.

The B5 is a heritage building with exquisite ceiling pattern and spatial character. The two long parallel walls had a differential settlement of more than 150mm, which is considerable. There is a strong need for immediate detailed investigation on the foundation of B5 so that appropriate underpinning actions could be taken.

The school was very poor for access of the physically challenged people. The school teachers, education department's representatives, a mason, etc. took part in the day long exercise in the field testing. It had made them adequately aware on the way one should look after a school to identify gaps and record data. The exercise was intended to enable the teachers and the community members to monitor the building and facilities on a regular basis.

of the existing building since all four hazards may not be applicable at every site. The condition assessment should be carried out by using the "Supplement". By comparing the needs of retrofitting and maintenance, the top level management can plan for retro-maintenance interventions. These two will enable the top level management to screen out those where detailed investigation will be necessary by involving the specialists.

This toolkit was not planned to be a finished product. However, it is suggested that the toolkit be used as it is for at least a few years. Only after the full cycle of data collection, analysis and decision making one may think of making modifications to fine tune the toolkit and to make it local specific.

## REFERENCES

1. Ahmed Shameem, Ahmed AH Towfique, (2010), Disaster Risks and Risk Mitigation in Dhaka/Other Cities, New Delhi.
2. Arya Anand S., (2007), Seismic Safety of Non-Structural Elements and Contents in Hospital Buildings, Draft Guide Version 1.0, Disaster Risk Management Programme, Government of India, UNDP New Delhi,
3. Building Bulletin 100 (2007), Design for fire safety in schools, Department for children, schools and families (UK)
4. Dixit Amod Mani, Acharya Surya Prasad (2010), Implementing Earthquake Vulnerability Reduction Program in Schools in Nepal, Workshop Report, National Workshop on School Earthquake Safety, Ministry of Education (MOE), Nepal, Asian Development Bank
5. FEMA 348 (1999), Protecting Building Utilities From Flood Damage, Principles and Practices for the Design and Construction of Flood Resistant, Building Utility Systems, Mitigation Directorate, 500 C Street, SW Washington, DC 20472
6. FEMA P-424 (2010), Risk Management Series, Design Guide for Improving School Safety in Earthquakes, Floods, and High Winds
7. FEMA 577 (2007), Risk Management Series, Design Guide for Improving Hospital Safety in Earthquakes, Floods, and High Winds
8. GFRDD (undated), Developing a Strategy for Improving Seismic Safety of Schools in Nepal, in cooperation with the Disaster Risk Management Practice Group of the World Bank South Asia Region
9. GHI (2001), Final Report Global Earthquake Safety Initiative (GESI), Pilot Project GeoHazards International, United Nations Centre for Regional Development
10. GHI (2005), Identifying Earthquake-Unsafe Schools And Setting Priorities To Make Them Safe, A Case Study In Gujarat, India, GeoHazards International,
11. Gibbs, T, Browne, H.E. (1982), The Barbados Homebuilder's Guide to Hurricane Resistant Design, National Council of Science and Technology, Bridgetown, Barbados
12. Government of Delhi, (2007), Non-Structural Risk Reduction Handbook for Schools, Steps Towards School Safety, Delhi Earthquake Safety Initiatives, Delhi Disaster Management Authority, GeoHazards International, SEEDS India, USAID
13. Guragain Ramesh, Pandey Bishnu Hari (2003), Non Structural Vulnerability Assessment of Hospitals in Nepal, Ministry of Health, Nepal, WHO, NSET, Nepal
14. Guragain Ramesh, Pandey Bishnu Hari, Shreshtha Surya Narayan (2004), Guidelines for Seismic Vulnerability Assessment of Hospitals, WHO, NSET, Nepal
15. Masri S., Caffrey J., Myrtle R., Nigbor R., Agbabian M., Johnson E., Petak W., hinozuka M., Tasbihgoo F., Tranquada R., Wellford L. (2004), The FEMA-USC Hospital Project: Non-structural Mitigation in Hospitals, Paper No. 2480, 13th World Conference on Earthquake Engineering, Vancouver, B.C., Canada
16. Merriman, P. A. and Browitt, C.W.A. Thomas Telford, London, pp.533-546
17. Monti G., Nuti C., Santini S., (1996), Seismic Assessment of Hospital Systems, Paper No 974, Eleventh World Conference on Earthquake Engineering, Elsevier Science Ltd.
18. Norton, J., Chantry, G. (1993), Promoting principles for better typhoon resistance in buildings- a case study in Vietnam. In: Natural Disasters: Protecting Vulnerable Communities, Edited by
19. ODA (1995), , Structures to Withstand Disasters, David Key (Ed.) , Institution of Civil Engineers, Thomas Telford, London
20. PAHO (2008), Hospital Safety Index, Evaluation Forms for Safe Hospitals, Pan American Health Organization, WHO, Washington.

21. Paulay, T, Priestley, M.J.N., (1992), *Seismic Design of Reinforced Concrete and Masonry Buildings*, John Wiley
22. Peduzzi P., Dao H., Herold C., and Mouton F. (2009), *Assessing global exposure and vulnerability towards natural hazards: the Disaster Risk Index*, *Natural Hazards and Earth System Sciences*, Nat. Hazards Earth Syst. Sci., 9, 1149–1159, 2009
23. SAARC DMC (2011), *Rapid Structural and Non Structural Assessment of School and Hospital Buildings in SAARC Countries*, SAARC Disaster Management Centre, New Delhi
24. The World Bank (2010), *Global Campaign on Making Cities Resilient, South Asia*, Global Facility for Disaster Reduction and Recovery, World Bank's global response to reduce the risks of disasters to sustainable development, New Delhi
25. UNISDR (2010), *Advocacy kit for parliamentarians, Disaster Risk Reduction: An Instrument for Achieving the Millennium Development Goals*
26. UNISDR, Asia and the Pacific (2010), *One Million Safe Schools and Hospitals Campaign, Guidance Notes, Assessment and Mitigation Planning for Risk Reduction*
27. UNISDR, Asia and the Pacific (2010), *One Million Safe Schools and Hospitals Campaign, Advocacy Guide*
28. UNISDR, Asia and the Pacific (2010), *One Million Safe Schools and Hospitals Campaign, Guidance Notes, School Emergency and Disaster Preparedness*
29. UNISDR, Asia and the Pacific (no date), *One Million Safe Schools and Hospitals Campaign, Guidance Notes, Emergency and Disaster Preparedness for Health Facilities*
30. WHO (2009), *Safe Hospitals in Emergencies and Disasters, Structural, Non-structural and Functional Indicators*, World Health Organization, Regional Office for the Western Pacific
31. WHO (undated), *Safe Hospitals Checklist*, Pan American Health Organization, Area on Emergency Preparedness and Disaster Relief





The Toolkit is aimed for the policy makers and local bodies that are responsible for local planning usually in urban areas in South Asia in order to assess critical infrastructure safety, particularly making schools and hospital safe.

Tools for the Assessment of School and Hospital safety for Multi-Hazards in South Asia comprised four books:

### **SCHOOL SAFETY TOOLKIT BOOK 1: NEW DESIGN / MULTI-HAZARD SAFETY COMPLIANCE**

#### **SCHOOL SAFETY TOOLKIT BOOK 2: RETRO-MAINTENANCE / MULTI-HAZARD SAFETY COMPLIANCE**

This book provides the following four sets of data collection forms: Seismic Safety Evaluation, Wind Safety Evaluation, Flood Safety Evaluation, Fire Safety Evaluation, and Condition Assessment. The surveyors/users should read these forms before initiating the investigation for retrofitting. Only the relevant forms should be used for examining safety compliance of the existing building since all four hazards may not be applicable in every site.

### **HOSPITAL SAFETY TOOLKIT BOOK 1: NEW DESIGN / MULTI-HAZARD SAFETY COMPLIANCE**

### **HOSPITAL SAFETY TOOLKIT BOOK 2: RETRO-MAINTENANCE / MULTI-HAZARD SAFETY COMPLIANCE**

Lead Technical Advisor for the development of the Toolkit, Dr Prabir Kumar Das is primarily working in India and the region of South Asia promoting community based social infrastructure construction consulting Governments, UN agencies and private sectors. His specific technical experience is in project appraisal, planning, implementation and maintenance management of community based construction, specially, education and healthcare facilities.



**WORLD URBAN CAMPAIGN**  
Better City. Better Life

**SUPPORTED BY**



**GFDRR**  
Global Facility for Disaster Reduction and Recovery

